

Technical descriptions

DESKTOPS AND CONFERENCE TABLES

MDF VENEERED TOPS

Made of 30 mm thick MDF, faced on both sides with 0.6 mm thick wood veneer and edged with 1 mm rounded solid wood with 2 mm radius. The tops have a tapered and rounded edge. Waterbased coating and clear open-pore finishing. The top is equipped with a 80 mm grommet cable hole. The conference tabletops can be shaped to house recessed socket boxes with lid openable longitudinally in both directions equipped with cable hole. The door has the same finish veneer and the same colour as the top.

LEATHER-UPHOLSTERED CONFERENCE TABLES

Made of 28 mm thick MDF, faced on both sides with soft and delicate eco leather. The tops have a tapered and rounded edge. The central wood panels can be shaped to house recessed socket boxes with lid openable longitudinally in both directions equipped with cable hole. The door has the same finish veneer and the same colour as the central panel.

SUPPORTING AND CONNECTING PEDESTALS FOR DESKS AND LEATHER-WOOD CONFERENCE TABLES

In the version with wood or leather-upholstered tops, the pedestals comprise 2 pairs of 5 mm thick laser-cut steel sheet profiles. Coated with matt black epoxy powder. Each pair is fastened through metal spacers screwed to one another. The pedestals are fastened to the chrome-plated metal supports already installed on the legs. Where the metal pedestals rest on a side element, they're fastened through 32 x 35 mm h chrome-plated metal cylinders.

GLASS CERAMIC TOPS

Made of 10 mm thick tempered glass, chamfered at 45 ° with a 6mm thick ceramic sheet glued to it. The tops are glued to the matte black epoxy powder painted metal beams using cylindrical metal spacers.

GLASS DESKTOPS AND CONFERENCE TABLES

Made of 12 mm thick clear tempered glass. Rounded flush clear edge. The tops are fastened to the chrome-plated metal pedestals underneath through 32 x 35 mm h cylinder metal spacers. Optional 80 mm diameter chrome-plated grommet cable hole. The conference tables feature a chrome-plated grommet cable hole on the top.

SUPPORTING AND CONNECTING PEDESTALS FOR DESKS AND GLASS CONFERENCE TABLES

In the version with glass tops, the pedestals comprise 2 pairs of 5 mm thick laser-cut steel sheet profiles. The chrome-plated pedestals are connected with 43 x 35 mm solid wood spacers with the same colour as the leg. Where the metal pedestals rest on a side element, they're fastened through 32 x 35 mm h chrome-plated metal cylinders. The pedestals are fastened to the chrome-plated metal supports already installed on the legs.

LEGS FOR DESKS AND CONFERENCE TABLES

Solid wood rounded and smooth legs, with waterbased coating and clear open-pore finishing. 53 mm thick, 800 x 690 mm h tripod legs. The base features a 6 mm adjustable foot. The two rounded slots within the leg feature chrome-plated metal supports to fasten the pedestals.

SERVICE CABINETS AND CUPBOARDS

Shell made of 18 mm white melamine veneer, E1 certification, or with polyurethane lacquered finishing, various colours. The 18 mm front panels can be made of white melamine, lacquered or faced on both sides with 6 mm wood veneer and edged with 1 mm rounded solid wood with 2 mm radius. The shell modules with different sizes are installed on a 38 mm thick melamine base with the same finish as the shells. The service cabinets for installation underneath the desk feature cable trays to house electric and IT cables underneath the service cabinets' top. The top is supported by 170 mm h solid wood feet with the same finish as the desk legs. Equipped with 6 mm adjustable foot. The 12 mm top can be finished with white melamine polyurethane lacquered wood or wood veneer. The 12 mm thick top has a white melamine, polyurethane lacquer or wood or ceramic veneer finish of 6mm with 12 mm melamine support.

MODESTY PANEL

Made of 18 mm chipboard panel, veneered as the desktop, and fastened to the pedestals through black metal connection brackets.

Eletrificazione · Electrification · Electrificación
Elektrisierung · Elektrificatie · Electrificación

I cavi sono alloggiati in un'ampia vaschetta e possono essere bloccati con fascette che si inseriscono in apposite fessure.

The cables are collected in a wide tray and can be locked with clamps inserted in special slots.

Les câbles sont logés dans un grand bac et peuvent être bloqués avec des colliers qui s'insèrent dans des fentes prévues à cet effet.

Die Kabel sind in einem großen Behälter enthalten und können durch Klemmen, durch vorgesehene Schlitz, blockiert werden.

De kabels worden ondergebracht in een ruime mand en kunnen geblokkeerd worden met behulp van klemmen die in de desbetreffende openingen worden gestoken.

Los cables están alojados en una amplia bandeja y pueden bloquearse con bridas, que se introducen en unas ranuras.

Lo spazio permette il passaggio dei cavi ad anta chiusa. La pressione esercitata dalle spazzole tiene in posizione i cavi.

The recess allows the passage of cables even with the door closed. The pressure exerted by the brushes maintains the cables in position.

L'espace permet le passage des câbles quand la porte est fermée. La pression exercée par les brosses maintient les câbles à leur emplacement.

Der ausreichende Raum ermöglicht die Kabeldurchführung bei geschlossener Tür. Der von den Bürsten ausgeübte Druck hält die Kabel in Position.

Het is mogelijk om de kabels erdoor te steken met een gesloten deur. De druk die door de borstels wordt uitgevoerd houdt de kabels op hun plaats.

El espacio permite el paso de los cables con la puerta cerrada. La presión ejercida por los cepillos mantiene los cables en su posición.

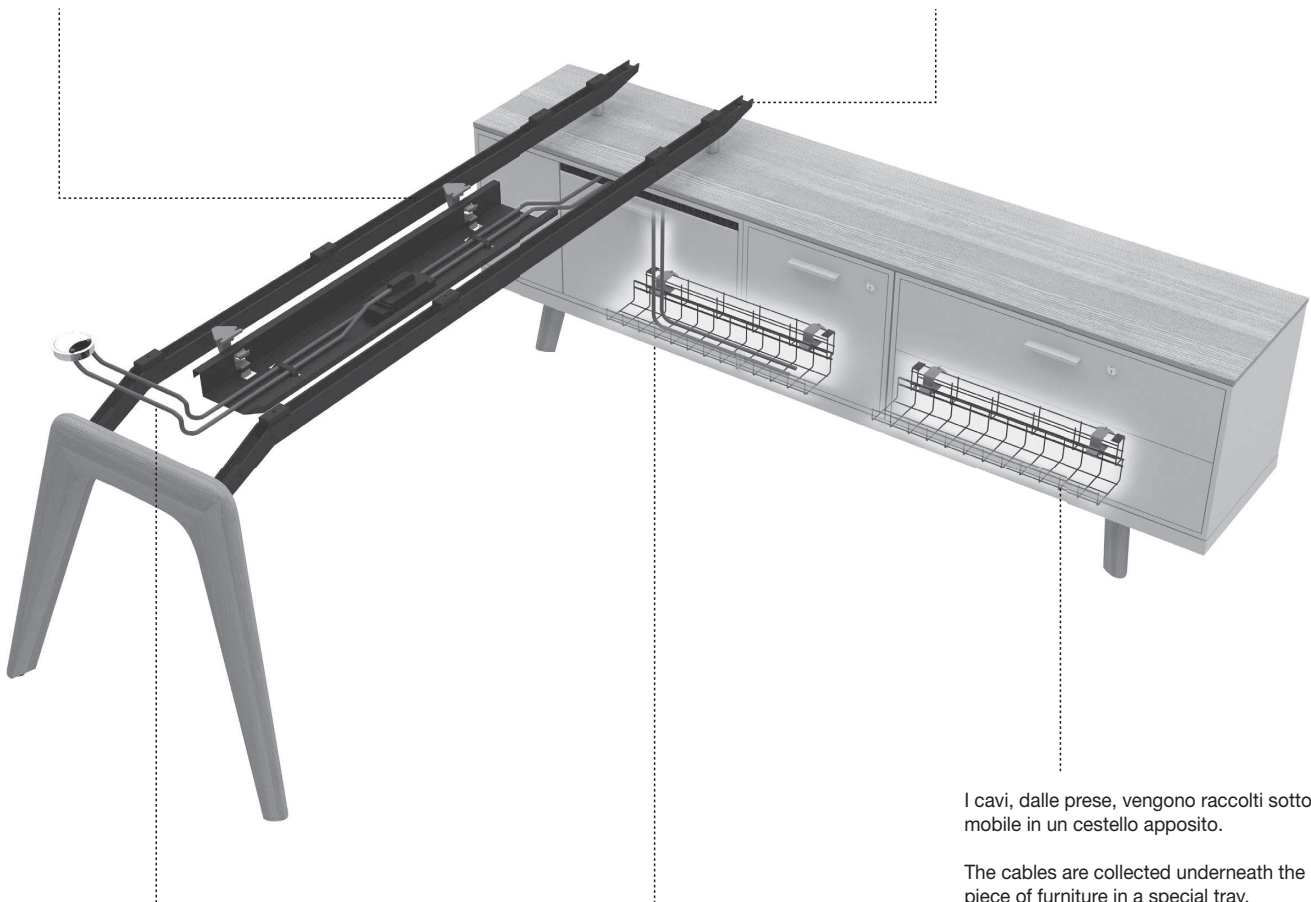

I cavi sono resi disponibili su piano attraverso appositi fori con sistema passacavi.

Cables are available on the top through cable grommet holes.

Les câbles arrivent sur le plateau à travers des trous avec un système passe-câbles.

Die Kabel stehen durch das Kabeldurchlasssystem auf der Tischplatte zur Verfügung.

De kabels worden beschikbaar gemaakt op het blad door speciale kabeldoorvoeropeningen.

Los cables resultan disponibles en el sobre gracias a unos orificios con sistema pasacables.

I cavi passano attraverso il mobile transitando da appositi passacavi.

Cables pass through the recesses within the piece of furniture.

Les câbles transitent dans des espaces situés à l'intérieur du meuble.

Die Kabel werden innerhalb des Schrankes geführt.

De kabels worden door ruimten aan de binnenkant van het meubel gestoken.

Los cables se extienden a lo largo de los espacios obtenidos en el interior del mueble.

I cavi, dalle prese, vengono raccolti sotto il mobile in un cestello apposito.

The cables are collected underneath the piece of furniture in a special tray.

À partir des prises, les câbles sont rassemblés sous le meuble dans un panier prévu pour cela.

Die Kabel werden von den Steckdosen unter dem Möbel in einem geeigneten Korb positioniert.

De kabels worden vanaf de stopcontacten onder het meubel in een speciale mand verzameld.

Los cables de las tomas de corriente se recogen debajo del mueble en una cesta.

Esempi · Examples · Exemples
Beispiele · Voorbeelden · Ejemplos

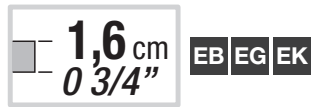

Scrivanie
Desks
Bureaux
Schreibtische
Bureaus
Escritorios

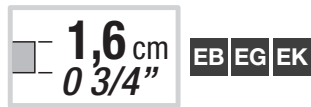
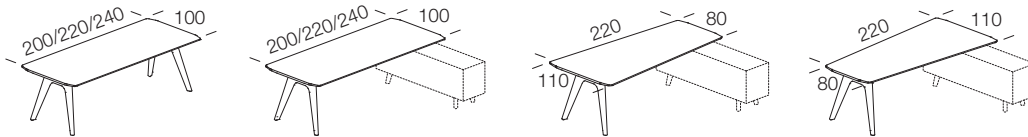

Tavoli riunione
Meeting tables
Table de réunion
Besprechungstisch
Wergadertafel
Mesa de reunión

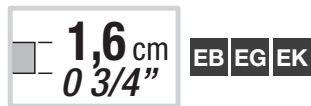
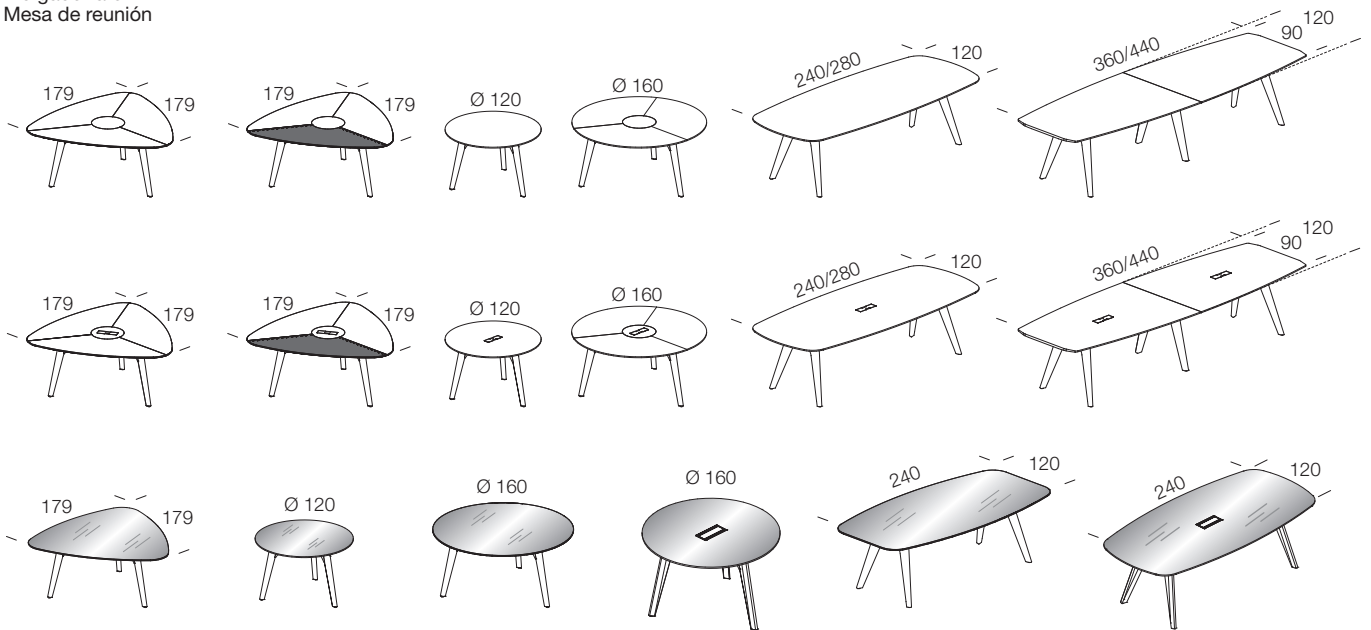

Tavolini da caffè
Coffee tables
Table basse
Couchtisch
Salontafel
Mesita para cortado

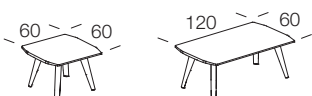

Scrivanie · Desks · Desks
Schreibtische · Bureaus · Escritorios

Gambe · Legs · Piètements Beine · Poten · Patas					
RB	RG	RK	RR	RT	
Piano · Worktop · Plan Platte · Werkblad · Plano					
RB	RG	RK	CK		EB EG EK
RR	RT				

W D H
cm cm cm
in in in

Cod.

Kg m³
LB ft³



4

4

6

Scrivania
Desk
Bureau
Schreibtisch
Bureau
Escritorio

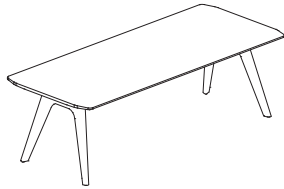

200	100	75	RS.2010.00	2.934	3.113	6.151	68	0,34	+ 4,69
78 3/4"	39 1/4"	29 1/2"					150	12	
220	100	75	RS.2210.00	3.049	3.260	6.343	74	0,36	+ 5,1
86 3/4"	39 1/4"	29 1/2"					163	13	
240	100	75	RS.2410.00	3.164	3.409	6.564	80	0,38	+ 5,5
94 1/2"	39 1/4"	29 1/2"					176	13	

Scrivania a ponte per aggancio al mobile di servizio
Bridge desk for hooking to a service cabinet
Bureau en pont pour fixation sur meuble de service
Schreibtisch Brückenkonstruktion zum Anhängen an Service-Möbel
Brugbureau voor vasthaking aan dienstmodulel
Escritorio en puente para enganchamiento al mueble de servicio

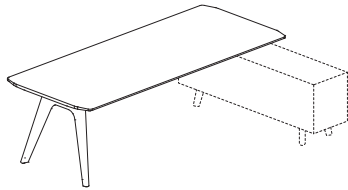

200	100	75	RS.2010.A0	2.519	2.623	5.736	63	0,28	+ 4,34
78 3/4"	39 1/4"	29 1/2"					140	10	
220	100	75	RS.2210.A0	2.634	2.820	5.928	69	0,29	+ 4,75
86 3/4"	39 1/4"	29 1/2"					153	10	
240	100	75	RS.2410.A0	2.750	3.019	6.150	75	0,31	+ 5,15
94 1/2"	39 1/4"	29 1/2"					166	11	

Scrivania a ponte per aggancio al mobile di servizio
Bridge desk for hooking to a service cabinet
Bureau en pont pour fixation sur meuble de service
Schreibtisch Brückenkonstruktion zum Anhängen an Service-Möbel
Brugbureau voor vasthaking aan dienstmodulel
Escritorio en puente para enganchamiento al mueble de servicio

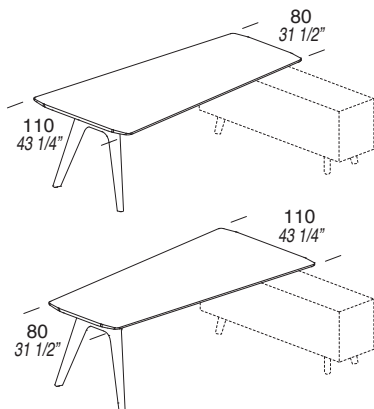

220	110	75	RS.2210.AC	2.818	2.995	6.133	74	0,31	+ 5,07
86 3/4"	43 1/4"	29 1/2"					163	11	

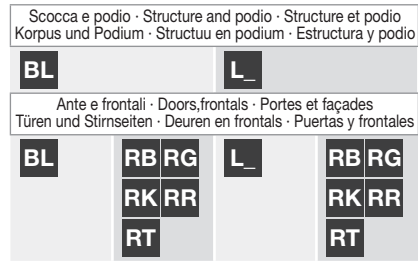

W D H
 cm cm cm
 in in in

Kg LB m³ ft³



2 cassetti con serratura,1 modulo tecnico,1 cestello portacavi
 2 drawers with lock,1 technical module,1 cable holder baskets
 2 tiroirs avec serrure,1 module technique,1 panier porte-câbles
 2 Schubladen mit Schloss,1 Module technique,1 Kabelkörbe
 2 lades met slot,1 technische module,1 kabelmand
 2 cajones con cerradura,1 módulo técnico,1 bandeja portacables

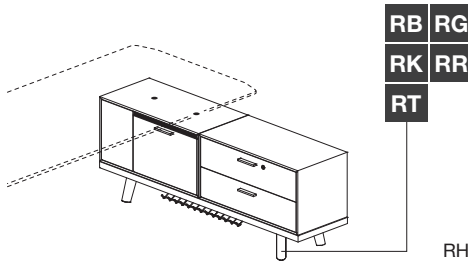

Aggiungere top obbligatorio
 Add compulsory top
 Ajouter le top obligatoire
 Hinzufügen obligatorische Abdeckplatte
 Toevoegen top binding
 Añadir parte superior obligatorio

RH	160,3 63"	40 15 3/4"	62,5 24 3/4"	RL.1606.D2	2.041	2.310	2.795	2.955	78 173	0,41 15	+ 6,13
----	--------------	---------------	-----------------	------------	-------	-------	-------	-------	-----------	------------	--------

2 cassetti con serratura,1 modulo tecnico,1 cestello portacavi
 2 drawers with lock,1 technical module,1 cable holder baskets
 2 tiroirs avec serrure,1 module technique,1 panier porte-câbles
 2 Schubladen mit Schloss,1 Module technique,1 Kabelkörbe
 2 lades met slot,1 technische module,1 kabelmand
 2 cajones con cerradura,1 módulo técnico,1 bandeja portacables

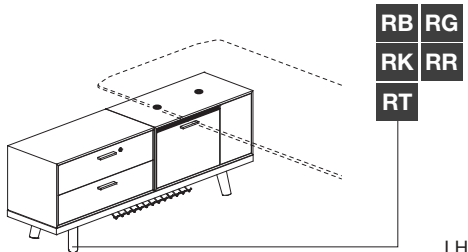

Aggiungere top obbligatorio
 Add compulsory top
 Ajouter le top obligatoire
 Hinzufügen obligatorische Abdeckplatte
 Toevoegen top binding
 Añadir parte superior obligatorio

LH	160,3 63"	40 15 3/4"	62,5 24 3/4"	RL.1606.S2	2.041	2.310	2.795	2.955	78 173	0,41 15	+ 6,13
----	--------------	---------------	-----------------	------------	-------	-------	-------	-------	-----------	------------	--------

Top con predisposizione per scrivania dx o sx
 Top with arrangement for desk Rh or Lh
 Top avec prédisposition pour bureau droite ou gauche
 Abdeckplatte mit vorbereitung für Schreibtische RE oder LI
 Top met een voorziening voor bureau Re of LI
 Plano superior con la disposición para escritorio derecho o izquierdo

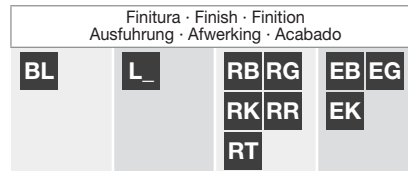
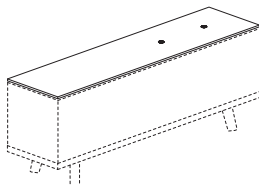

	160,6 63 1/4"	40 15 3/4"	1,2 0 3/4"	RT.1604.SE	71	204	270	1.165	5 12	0,03 1	+ 0,42
--	------------------	---------------	---------------	------------	----	-----	-----	-------	---------	-----------	--------

Mobili di servizio sottoscrivania · Support service modules · Modules de service de soutien
 Unterstützung-Service-Module · Dienstmodules ondersteuning · Módulos de servicios de apoyo

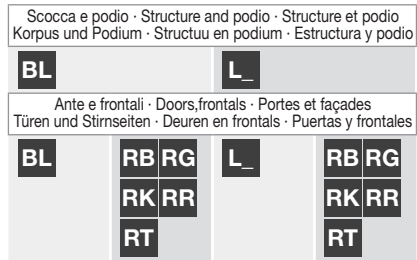

W D H
 cm cm cm
 in in in

Kg LB
 m³ ft³



2 ante con serratura,1 modulo tecnico,1 cestello portacavi
 2 doors with lock,1 technical module,1 cable holder baskets
 2 portes avec serrure,1 module technique,1 panier porte-câbles
 2 türen mit Schloss,1 Module technique,1 Kabelkörbe
 2 deurtjes met slot, technische module,1 kabelmand
 2 puertas con cerradura,1 módulo técnico 1 bandeja portacables

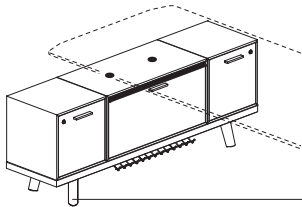

Aggiungere top obbligatorio
 Add compulsory top
 Ajouter le top obligatoire
 Hinzufügen obligatorische Abdeckplatte
 Toevoegen top binding
 Añadir parte superior obligatorio

160,3 63 ⁹ / ₁₆	40 15 3/4"	62,5 24 3/4"	RL.1606.AR	1.966	2.238	2.900	3.063	67 149	0,42 15	+ 5,33
--	---------------	-----------------	------------	-------	-------	-------	-------	-----------	------------	--------

Top con predisposizione per scrivania centrale al mobile di servizio
 Top with arrangement for central desk to the service module
 Top avec prédisposition pour bureau central sur meuble de service
 Abdeckplatte mit vorbereitung für zentral Schreibtische an Service-Möbel
 Top met een voorziening voor bureau centraal aan dienstmodule
 Plano superior con la disposición para escritorio central al mueble de servicio

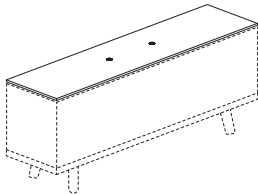

160,6 63 1/4"	40 15 3/4"	1,2 0 3/4"	RT.1604.SC	71	204	270	1.165	5 12	0,03 1	+ 0,42
------------------	---------------	---------------	------------	----	-----	-----	-------	---------	-----------	--------

Scocca e podio · Structure and podio · Structure et podio Korpus und Podium · Structuu en podium · Estructura y podio			
BL			L_
Ante e frontali · Doors,frontals · Portes et façades Türen und Stirnseiten · Deuren en frontals · Puertas y frontales			
BL	RB RG	L_	RB RG
	RK RR		RK RR
	RT		RT

W D H
cm cm cm
in in in

Kg LB m³ ft³



4	4	4	4
---	---	---	---

1 anta e 2 cassetti con serratura,1 modulo tecnico,2 cestelli portacavi
 1 door and 2 drawers with lock,1 technical module,2 cable holder baskets
 1 porte et 2 tiroirs avec serrure,1 module technique,2 paniers porte-câbles
 1 Tür und 2 Schubladen mit Schloss,1 Module technique,2 Kabelkörben
 1 deur en 2 lades met slot,1 technische module,2 kabelgoten
 1 puerta y 2 cajones con cerradura,1 módulo técnico,2 bandejas portacables

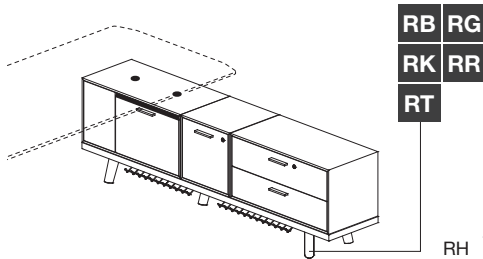

Aggiungere top obbligatorio
 Add compulsory top
 Ajouter le top obligatoire
 Hinzufügen obligatorische Abdeckplatte
 Toevoegen top binding
 Añadir parte superior obligatorio

RH	200,6 79"	40 15 3/4"	62,5 24 3/4"	RL.2006.D2	2.540	2.881	3.531	3.732	97 214	0,53 19	+ 7,61
----	--------------	---------------	-----------------	------------	-------	-------	-------	-------	-----------	------------	--------

1 anta e 2 cassetti con serratura,1 modulo tecnico,2 cestelli portacavi
 1 door and 2 drawers with lock,1 technical module,2 cable holder baskets
 1 porte et 2 tiroirs avec serrure,1 module technique,2 paniers porte-câbles
 1 Tür und 2 Schubladen mit Schloss,1 Module technique,2 Kabelkörben
 1 deur en 2 lades met slot,1 technische module,2 kabelgoten
 1 puerta y 2 cajones con cerradura,1 módulo técnico,2 bandejas portacables

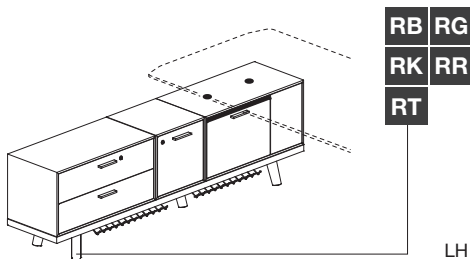

Aggiungere top obbligatorio
 Add compulsory top
 Ajouter le top obligatoire
 Hinzufügen obligatorische Abdeckplatte
 Toevoegen top binding
 Añadir parte superior obligatorio

LH	200,6 79"	40 15 3/4"	62,5 24 3/4"	RL.2006.S2	2.540	2.881	3.531	3.732	97 214	0,53 19	+ 7,61
----	--------------	---------------	-----------------	------------	-------	-------	-------	-------	-----------	------------	--------

Top con predisposizione per scrivania dx o sx
 Top with arrangement for desk Rh or Lh
 Top avec prédisposition pour bureau droite ou gauche
 Abdeckplatte mit vorbereitung für Schreibtische RE oder LI
 Top met een voorziening voor bureau Re of LI
 Plano superior con la disposición para escritorio derecho o izquierdo

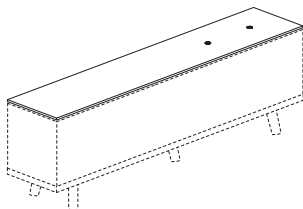

Finitura · Finish · Finition Ausführung · Afwerking · Acabado			
BL	L_	RB RG	EB EG
		RK RR	EK
		RT	

4	4	4	6
---	---	---	---

	200,7 79"	40 15 3/4"	1,2 0 3/4"	RT.2004.SE	83	245	335	1.345	7 15	0,04 1	+ 0,52
--	--------------	---------------	---------------	------------	----	-----	-----	-------	---------	-----------	--------

Mobili di servizio sottoscrivania · Support service modules · Modules de service de soutien
 Unterstützung-Service-Module · Dienstmodules ondersteuning · Módulos de servicios de apoyo

Scocca e podio · Structure and podio · Structure et podio Korpus und Podium · Structuu en podium · Estructura y podio					
BL					L_
Ante e frontali · Doors,frontals · Portes et façades Türen und Stirnseiten · Deuren en frontals · Puertas y frontales					
BL	RB	RG	L_	RB	RG
	RK	RR		RK	RR
	RT			RT	

W D H
cm cm cm
in in in

Cod.

Kg m³
LB ft³



4	4	4	4
---	---	---	---

2 ante ribalta con serratura,1 modulo tecnico,2 cestelli portacavi
 2 drop-leaf doors with lock,1 technical module,2 cable holder baskets
 2 portes escamotable avec serrure,1 module technique,2 paniers porte-câbles
 2 Klapptüren mit Schloss,1 Module technique,2 Kabelkörbe
 2 bovenklapdeuren met slot,1 technische module,2 kabelmanden
 2 puertas basculante con cerradura,1 módulo técnico,2 bandeja portacables

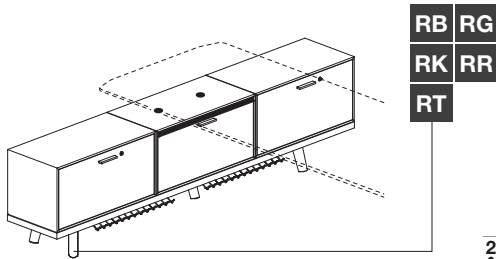

Aggiungere top obbligatorio
 Add compulsory top
 Ajouter le top obligatoire
 Hinzufügen obligatorische Abdeckplatte
 Toevoegen top binding
 Añadir parte superior obligatorio

240,9	40	62,5	RL.2406.R3	2.674	3.080	3.844	4.083	100	0,63	+ 7,77
94 3/4"	15 3/4"	24 3/4"						220	22	

Top con predisposizione per scrivania centrale al mobile di servizio
 Top with arrangement for central desk to the service module
 Top avec prédisposition pour bureau central sur meuble de service
 Abdeckplatte mit vorbereitung für zentral Schreibtische an Service-Möbel
 Top met een voorziening voor bureau centraal aan dienstmodule
 Plano superior con la disposición para escritorio central al mueble de servicio

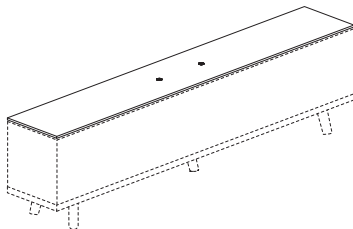

Finitura · Finish · Finition Ausführung · Afwerking · Acabado					
BL	L_	RB	RG	EB	EG
		RK	RR	EK	
		RT			
4	4	4	6		

240,9	40	1,2	RT.2404.SC	97	286	401	1.717	8	0,04	+ 0,63
94 3/4"	15 3/4"	0 3/4"						18	1	

Finitura · Finish · Finition
Ausführung · Afwerking · Acabado

RB RG RK RR RT

W D H
cm cm cm
in in in

Cod.

Kg m³
LB ft³



4

Modesty pannello H.28
Modesty pannello H.28
Voile de fond H.28
Knieraumblende H.28
Bureauborden H.28
Panela para escritorio H.28

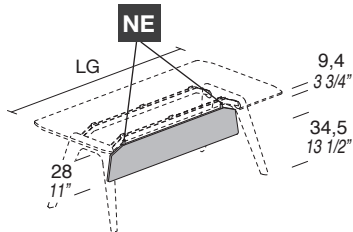

No per scrivanie con piani vetro
Not for desks with glass top
Non pour les bureaux avec plan en verre
Nicht für Schreibtische mit glas Tischplatte
Niet voor bureau met blad van glas
No para mesas con tapas de vidrio

LG	W	D	H	Cod.	Price	Weight	Volume	Extra
200 78 3/4"	152 59 3/4"	1,9 0 3/4"	28 11"	RG.1503.00	399	6 13	0,03 1	+ 0,41
220 86 3/4"	172 67 3/4"	1,9 0 3/4"	28 11"	RG.1703.00	414	7 15	0,03 1	+ 0,46
240 94 1/2"	192 75 1/2"	1,9 0 3/4"	28 11"	RG.1903.00	429	8 17	0,03 1	+ 0,51

Modesty pannello per scrivania a ponte H.28
Modesty panel for bridge desk H.28
Voile de fond pour bureau en pont H.28
Knieraumblende für Schreibtisch Brückenkonstruktion H.28
Bureauborden voor brugbureau H.28
Panela para escritorio para escritorio en puente H.28

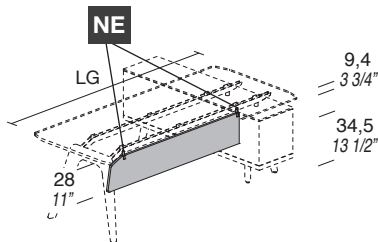

No per scrivanie con piani vetro
Not for desks with glass top
Non pour les bureaux avec plan en verre
Nicht für Schreibtische mit glas Tischplatte
Niet voor bureau met blad van glas
No para mesas con tapas de vidrio

LG	W	D	H	Cod.	Price	Weight	Volume	Extra
200 78 3/4"	135 53"	1,9 0 3/4"	28 11"	RG.1403.00	374	5 12	0,02 1	+ 0,36
220 86 3/4"	155 61"	1,9 0 3/4"	28 11"	RG.1603.00	389	6 14	0,03 1	+ 0,41
240 94 1/2"	175 68 3/4"	1,9 0 3/4"	28 11"	RG.1803.00	404	7 15	0,03 1	+ 0,46

Tavolino basso
Low table
Petite table basse
Niedriger Tisch
Laag tafeltje
Mesita baja



Gambe · Leg · Piètements
Beine · Poten · Patas

RB RG RK RR RT

Piano · Worktop · Plan
Platte · Werkblad · Plano

RB RG RK RR

EB EG EK

RT

4

6

W	D	H	Cod.	Price	Price	Weight	Volume	Extra
60 23 3/4"	60 23 3/4"	40 15 3/4"	RT.0606.00	849	1.499	11 25	0,04 1	+ 0,76
120 47 1/4"	60 23 3/4"	40 15 3/4"	RT.1206.00	1.021	2.040	19 42	0,06 2	+ 1,3

Finitura · Finish · Finition
 Ausführung · Afwerking · Acabado
KR

W **D** **H** Cod.
 cm cm cm
 in in in

Kg m³
 LB ft³



4



Tappo passacavi in metallo per piani legno e pelle
 Metal grommet cable holder for wooden or leather tops
 Passe câbles en métal pour plan en bois ou cuir
 Metal Kabeldurchlass für Holz und Leder Tischplatte
 Metalen Kabeldoorvoerkop voor blad van hout en leder
 Tapas pasacables en metal para plano de madera o de piel

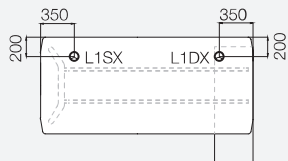
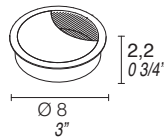
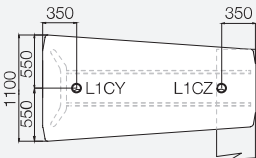

$\frac{8}{3}$	$\frac{8}{3}$	$\frac{2.2}{0.3/4}$	RZ.0008.A0	19	0	0	+ 0,01
---------------	---------------	---------------------	-------------------	-----------	---	---	--------

Con applicazione · With application · Avec l'application
 Mit Anwendung · Met montage · Con aplicación

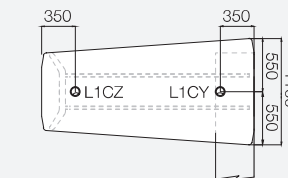

$\frac{8}{3}$	$\frac{8}{3}$	$\frac{2.2}{0.3/4}$	RZ.0008.00	66	0	0	+ 0,01
---------------	---------------	---------------------	-------------------	-----------	---	---	--------

Tappo passacavi in metallo per piani vetro
 Metal grommet cable holder for glass tops
 Passe câbles en métal pour plan en verre
 Metal Kabeldurchlass für Glass Tischplatte
 Metalen Kabeldoorvoerkopi voor blad van glas
 Tapas pasacables en metal para tapas de vidrio

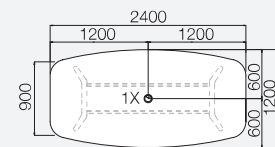
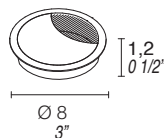
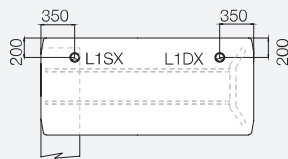

$\frac{8}{3}$	$\frac{8}{3}$	$\frac{1.2}{0.1/2}$	RZ.0008.V0	19	0	0	+ 0,01
---------------	---------------	---------------------	-------------------	-----------	---	---	--------

Con applicazione · With application · Avec l'application
 Mit Anwendung · Met montage · Con aplicación

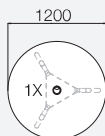

$\frac{8}{3}$	$\frac{8}{3}$	$\frac{1.2}{0.1/2}$	RZ.0008.AV	115	0	0	+ 0,01
---------------	---------------	---------------------	-------------------	------------	---	---	--------

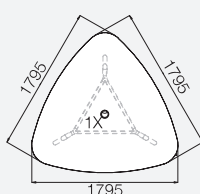
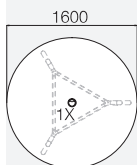

Finitura · Finish · Finition
Ausführung · Afwerking · Acabado

KR

W D H
cm cm cm
in in in

Cod.

Kg m³
LB ft³



2

Passacavi verticale con spazzola
Vertebra cable guide with brush strip and base
Vertèbre passe câbles avec brosse et base
Vertikale Elektrifizierung durch Kabelspirale KR
Kabelslurf met basis
Vértebra pasacables con cepillo y base

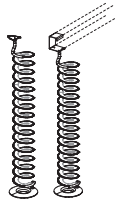

01 V1

Piano legno o pelle · Wooden or leather top · Plan en bois ou cuir
Holz und Leder Tischplatte · Blad in hout en leder · Plano de madera y piel

20 7 3/4"	10 4"	10 4"	GZ.0160.01	142	1 2	0 0	+ 0,02
--------------	----------	----------	-------------------	------------	--------	--------	--------

Piano vetro · Glass top · Plan en verre
Glas Tischplatte · Blad in glas · Plano de vidrio

20 7 3/4"	10 4"	10 4"	GZ.0160.V1	165	1 3	0,01 0	+ 0,02
--------------	----------	----------	-------------------	------------	--------	-----------	--------

Vaschetta portacavi (con attacchi per piani legno)
Cables holder baskets (with attacks for wooden tops)
Bac porte-cables (avec fixations pour plan en bois)
Kabel halterkörbchen (mit anschlüssen für Holz Tischplatte)
Kabels houer manden (met contractpunten voorblad van hout)
Cestos portaenchufes (con uniones para tapas de madera)

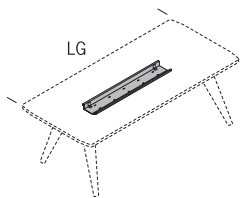

LG

Finitura · Finish · Finition
Ausführung · Afwerking · Acabado

NF

2

LG

200/220 78 3/4/86 3/4"	89 35"	19,6 7 3/4"	5,9 2 1/4"	MZ.0090.01	72	3 6	0,02 1	+ 0,05
240 94 1/2"	109 43"	19,6 7 3/4"	5,9 2 1/4"	MZ.0110.01	77	3 7	0,02 1	+ 0,05

Tavoli riunione e conferenza · Meeting and conference tables · Tables de réunion et de conférence Sitzung un Konferenztische · Vergader en conferentientafels · Mesas reunión y conferencia



Top access e vaschetta compresi · Top-access and wire tray included
Top Access et portillon inclus · Top-Zugang und Klappen inklusive
Top toegang en klep inbegrepen · Acceso superior y Puerta incluida

Gambe e piano centrale · Leg and central top · Piètement et plateau central
Bein und zentral planen · Pot en blad centraal · Pata y plano central

RB RG RK RR RT

Piano · Worktop · Plan
Platte · Werkblad · Plano

RB RG RK RR

PA PE PH

RT

W D H
cm cm cm
in in in

Cod.

Kg m³
LB ft³



4

4

Scrivania-Tavolo triangolare 3 piani (6 posti)
Desk-Triangular table 3 tops (6 seater)
Bureau-Table triangulaire 3 plans (6 places)
Schreibtische-Tisch dreieckig 3 platten (6 Personen)
Bureau-Driehoekig tafel 3 bladen (6 plaatsen)
Escritorio-Mesa triangular 3 planos (6 puestos)



RT.1616.T3

RT.1616.TV

179.4 171.6 75
70 3/4" 67 1/2" 29 1/2"

RT.1616.T3

4.545

4.839

103 0.66
228 23

+ 7,11



179.4 171.6 75
70 3/4" 67 1/2" 29 1/2"

RT.1616.TV

4.743

5.037

105 0.67
230 24

+ 7,18

Scrivania-Tavolo triangolare 2 piani legno, 1 rivestito in pelle (6 posti)
Desk-Triangular table 2 wooden tops, 1 covered in leather (6 seater)
Bureau-Table triangulaire 2 plan en bois, 1 revêtu en cuir (6 places)
Schreibtische-Tisch dreieckig 2 Holz platten, 1 Leder-beschichtet (6 Personen)
Bureau-Driehoekig tafel 2 bladen van hout, 1 bedekt in leder (6 plaatsen)
Escritorio-Mesa triangular 2 planos de madera, 1 revestido de piel (6 puestos)

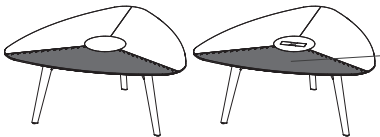

RT.1616.P3

RT.1616.PV

179.4 171.6 75
70 3/4" 67 1/2" 29 1/2"

RT.1616.P3

4.643

-

103 0.65
228 23

+ 7,1



179.4 171.6 75
70 3/4" 67 1/2" 29 1/2"

RT.1616.PV

4.841

-

104 0.66
230 23

+ 7,17

Tavolo rotondo (4 posti)
Round table (4 seater)
Table ronde (4 places)
Runder Tisch (4 Personen)
Ronde tafel (4 plaatsen)
Mesa redonda (4 puestos)



RT.D120.00

RT.D120.V0

120 120 75
47 1/4" 47 1/4" 29 1/2"

RT.D120.00

1.841

1.947

41 0.32
90 11

+ 2,8



120 120 75
47 1/4" 47 1/4" 29 1/2"

RT.D120.V0

2.041

-

42 0.33
92 12

+ 2,87

Tavolo rotondo 3 piani (6 posti)
Round table 3 tops (6 seater)
Table ronde 3 plans (6 places)
Runder Tisch 3 Tischplatte (6 Personen)
Ronde tafel 3 bladen (6 plaatsen)
Mesa redonda 3 planos (6 puestos)

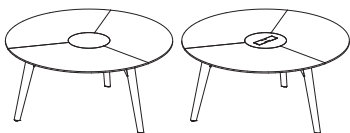

RT.D160.00

RT.D160.V3

160 160 75
63" 63" 29 1/2"

RT.D160.00

3.786

4.014

97 0.64
214 23

+ 6,65



160 160 75
63" 63" 29 1/2"

RT.D160.V3

3.984

4.212

98 0.65
216 23

+ 6,72

Tavoli riunione e conferenza · Meeting and conference tables · Tables de réunion et de conférence
Sitzung un Konferenztische · Vergader en conferentietafels · Mesas reunión y conferencia

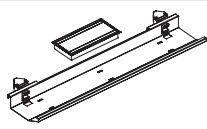

Top access GZ.0062.A3 e vaschetta MZ.0110.01 compresi
Top-access GZ.0062.A3 and cables holder baskets MZ.0110.01 included
Top Access GZ.0062.A3 et bac porte-cables MZ.0110.01 inclus
Top-Zugang GZ.0062.A3 und Kabel halterkörbchen MZ.0110.01 inklusive
Top toegang GZ.0062.A3 en korfje MZ.0110.01 inbegrepen
Acceso superior GZ.0062.A3 y cestos portaenchufes MZ.0110.01 incluida

Gambe e piano centrale · Leg and central top · Piètement et plateau central
Bein und zentral planen · Pot en blad centraal · Pata y plano central

RB RG RK RR RT

Piano · Worktop · Plan
Platte · Werkblad · Plano

RB RG RK RR RT

W D H
cm cm cm
in in in

Cod.

Kg LB m³ ft³



4

Tavolo sagomato (8/10 posti)
Shaped table (8/10 seater)
Table formé (8/10 places)
Tisch geformt (8/10 Personen)
Gevormd tafel (8/10 plaatsen)
Mesa perfilado (8/10 puestos)

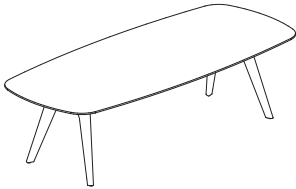

RT.2412.00
RT.2812.00

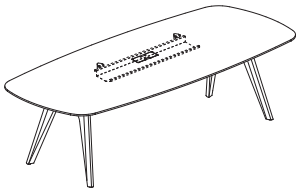

RT.2412.V0
RT.2812.V0

240 94 1/2"	120 47 1/4"	75 29 1/2"	RT.2412.00	3.326	87 192	0,4 14	+ 5,99
280 110 1/4"	120 47 1/4"	75 29 1/2"	RT.2812.00	3.726	100 221	0,44 16	+ 6,92
240 94 1/2"	120 47 1/4"	75 29 1/2"	RT.2412.V0	3.694	90 198	0,42 15	+ 6,2
280 110 1/4"	120 47 1/4"	75 29 1/2"	RT.2812.V0	4.093	103 228	0,46 16	+ 7,13

Tavolo sagomato (12/16 posti)
Shaped table (12/16 seater)
Table formé (12/16 places)
Tisch geformt (12/16 Personen)
Gevormd tafel (12/16 plaatsen)
Mesa perfilado (12/16 puestos)

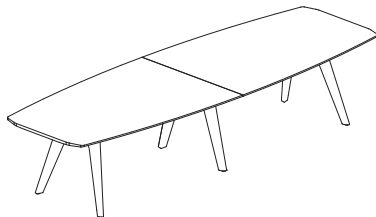

RT.3612.00
RT.4412.00

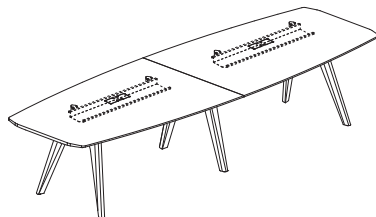

RT.3612.V2
RT.4412.V2

360 141 3/4"	120 47 1/4"	75 29 1/2"	RT.3612.00	5.625	129 284	0,8 28	+ 8,88
440 173 1/4"	120 47 1/4"	75 29 1/2"	RT.4412.00	6.557	165 364	0,88 31	+ 11,38
360 141 3/4"	120 47 1/4"	75 29 1/2"	RT.3612.V2	6.069	135 298	0,84 30	+ 9,3
440 173 1/4"	120 47 1/4"	75 29 1/2"	RT.4412.V2	7.003	171 378	0,92 33	+ 11,8

Tavoli riunione e conferenza · Meeting and conference tables · Tables de réunion et de conférence
Sitzung un Konferenztische · Vergader en conferentientafels · Mesas reunión y conferencia

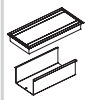

Top access GZ.0062.A3 e vaschetta compresi
Top-access GZ.0062.A3 and wire tray included
Top Access GZ.0062.A3 et portillon inclus
Top-Zugang GZ.0062.A3 und Klappen inklusive
Top toegang GZ.0062.A3 en klep inbegrepen
Acceso superior GZ.0062.A3 y puerta incluida

Gambe · Legs · Piètements Beine · Poten · Patas					
RB	RG	RK	RR	RT	
Piano · Worktop · Plan Platte · Werkblad · Plano					
CK			EB	EG	EK

W D H
cm cm cm
in in in

Cod.

Kg m³
LB ft³



4

6

Tavolo rotondo (4 posti)
Round table (4 seater)
Table ronde (4 places)
Runder Tisch (4 Personen)
Ronde tafel (4 plaatsen)
Mesa redonda (4 puestos)

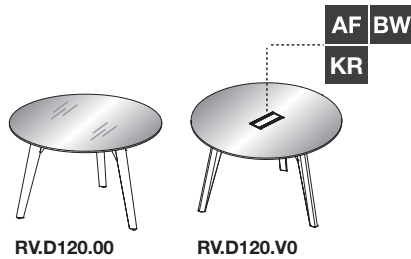

120 47 1/4"	120 47 1/4"	75 29 1/2"	RV.D120.00	2.105	3.905	60 132	0,38 13	+ 4,13
-----------------------	-----------------------	----------------------	-------------------	--------------	--------------	-----------	------------	---------------



120 47 1/4"	120 47 1/4"	75 29 1/2"	RV.D120.V0	-	4.053	71 157	0,4 14	+ 4,33
-----------------------	-----------------------	----------------------	-------------------	---	--------------	-----------	-----------	---------------

Tavolo rotondo (6 posti)
Round table (6 seater)
Table ronde (6 places)
Runder Tisch (6 Personen)
Ronde tafel (6 plaatsen)
Mesa redonda (6 puestos)

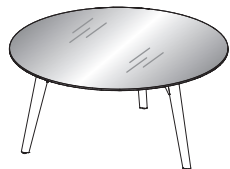

160 63"	160 63"	75 29 1/2"	RV.D160.00	3.732	-	107 236	0,65 23	+ 7,35
-------------------	-------------------	----------------------	-------------------	--------------	---	------------	------------	---------------

Tavolo triangolare (6 posti)
Triangular table (6 seater)
Table triangulaire (6 places)
Tisch dreieckig (6 Personen)
Driehoekig tafel (6 plaatsen)
Mesa triangular (6 puestos)

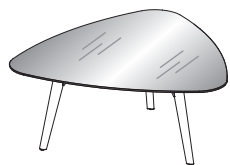

179.4 70 3/4"	171.6 67 1/2"	75 29 1/2"	RV.1616.00	4.330	-	148 326	0,7 25	+ 10,18
-------------------------	-------------------------	----------------------	-------------------	--------------	---	------------	-----------	----------------

Tavoli riunione e conferenza · Meeting and conference tables · Tables de réunion et de conférence
Sitzung un Konferenztische · Vergader en conferentientafels · Mesas reunión y conferencia



Top access GZ.0062.A3 e vaschetta compresi
Top-access GZ.0062.A3 and wire tray included
Top Access GZ.0062.A3 et portillon inclus
Top-Zugang GZ.0062.A3 und Klappen inklusive
Top toegang GZ.0062.A3 en klep inbegrepen
Acceso superior GZ.0062.A3 y puerta incluida

Gambe · Legs · Piètements Beine · Poten · Patas					
RB	RG	RK	RR	RT	
Piano · Worktop · Plan Platte · Werkblad · Plano					
CK			EB	EG	EK

W D H
cm cm cm
in in in

Cod.



4

6

Tavolo sagomato (8 posti)
Shaped table (8 seater)
Table formé (8 places)
Tisch geformt (8 Personen)
Gevormd tafel (8 plaatsen)
Mesa perfilado (8 puestos)

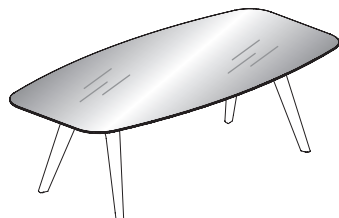

RV.2412.00

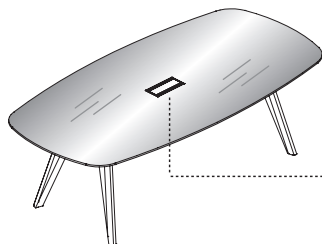

RV.2412.V0

AF **BW**
KR

240 94 1/2"	120 47 1/4"	75 29 1/2"	RV.2412.00	3.486	6.802	136 300	0,46 16	+ 9,41
240 94 1/2"	120 47 1/4"	75 29 1/2"	RV.2412.V0	-	6.965	159 350	0,49 17	+ 9,73

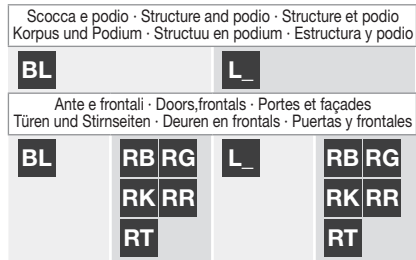

W D H
cm cm cm
in in in

Cod.

Kg m³
LB ft³



Mobile con 2 cassetti con serratura
Service module with 2 drawers with lock
Meuble de service avec 2 tiroirs avec serrure
Servicemodul mit 2 Schubladen mit Schloss, Holz Tischplatte
Servicemodulen met 2 lades met slot
Módulos de servicio con 2 cajones con cerradura

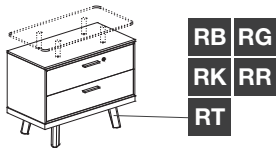

Aggiungere top obbligatorio
Add compulsory top
Ajouter le top obligatoire
Hinzufügen obligatorische Abdeckplatte
Toevoegen top binding
Añadir parte superior obligatorio

80 31 1/2"	40 15 3/4"	62,8 24 3/4"	RC.0804.N0	1.236	1.377	1.614	1.693	46 101	0,22 8	+ 3,61
---------------	---------------	-----------------	------------	-------	-------	-------	-------	-----------	-----------	--------

Mobile con 2 cassetti e 1 anta con serratura
Service module with 1 door and 2 drawers with lock
Meuble de service avec 1 porte e 2 tiroirs avec serrure
Servicemodul mit 1 Tür und 2 Schubladen mit Schloss
Servicemodulen met 1 deur en 2 lades met slot
Módulos de servicio con 1 puerta y 2 cajones con cerradura

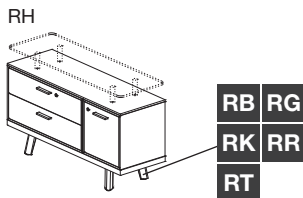
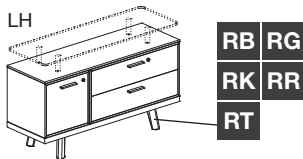

Aggiungere top obbligatorio
Add compulsory top
Ajouter le top obligatoire
Hinzufügen obligatorische Abdeckplatte
Toevoegen top binding
Añadir parte superior obligatorio

RH	120,3 47 1/4"	40 15 3/4"	62,8 24 3/4"	RC.1204.NR	1.578	1.791	2.208	2.328	64 141	0,33 12	+ 5,06
LH	120,3 47 1/4"	40 15 3/4"	62,8 24 3/4"	RC.1204.NL	1.578	1.791	2.208	2.328	64 141	0,33 12	+ 5,06

Top
Top
Top
Top
Topblad
Parte superior

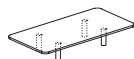

RT.0804.01



RT.1204.01



80 31 1/2"	40 15 3/4"	12,7 4 1/2"	RT.0804.01	499	499	752	10 22	0,05 2	+ 0,65
120 47 1/4"	40 15 3/4"	12,7 4 1/2"	RT.1204.01	563	563	1.028	13 29	0,06 2	+ 0,88

Credenze · Storage units · Desserte
Beistellmöbel · Dressoir · Aparador

Scocca e podio · Structure and podio · Structure et podio Korpus und Podium · Structuu en podium · Estructura y podio					
BL		L			
Ante e frontali · Doors,frontals · Portes et façades Türen und Stirnseiten · Deuren en frontals · Puertas y frontales					
BL		RB RG		L	
		RK RR		RB RG	
		RT		RK RR	
				RT	

W D H
cm cm cm
in in in

Cod.

Kg m³
LB ft³



4	4	4	4
---	---	---	---

2 ante a ribalta con serratura
Storage unit with 2 drop-leaf doors with lock
Desserte avec 2 portes escamotable avec serrure
Beistellmöbel mit 2 Klapptüren mit Schloss
Dressoir met 2 bovenklapdeuren met slot
Aparador con 2 puertas basculante con cerradura

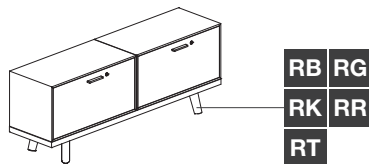

Aggiungere top obbligatorio
Add compulsory top
Ajouter le top obligatoire
Hinzufügen obligatorische Abdeckplatte
Toevoegen top binding
Añadir parte superior obligatorio

160,3 63"	40 15 3/4"	62,5 24 3/4"	RC.1606.R2	1.678	1.956	2.356	2.514	66 146	0,41 14	+ 5,11
--------------	---------------	-----------------	------------	-------	-------	-------	-------	-----------	------------	--------

2 ante a ribalta con serratura,2 estraibili con serratura
2 drop-leaf doors with lock,2 extractables with lock
2 portes escamotable avec serrure,2 extractibles avec serrure
2 Klapptüren mit Schloss,2 abnehmbare mit Schloss
2 bovenklapdeuren met slot 2 extraheerbare met slot
2 puertas basculante con cerradura,2 extraibles con cerradura

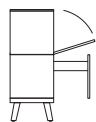
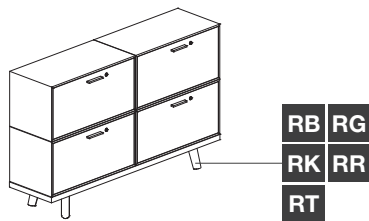

Aggiungere top obbligatorio
Add compulsory top
Ajouter le top obligatoire
Hinzufügen obligatorische Abdeckplatte
Toevoegen top binding
Añadir parte superior obligatorio

160,3 63"	40 15 3/4"	102,5 40 1/4"	RC.1610.R4	2.686	3.242	3.944	4.262	119 261	0,77 27	+ 9,08
--------------	---------------	------------------	------------	-------	-------	-------	-------	------------	------------	--------

Credenze · Storage units · Desserte
Beistellmöbel · Dressoir · Aparador

Scocca e podio · Structure and podio · Structure et podio
Korpus und Podium · Structuu en podium · Estructura y podio

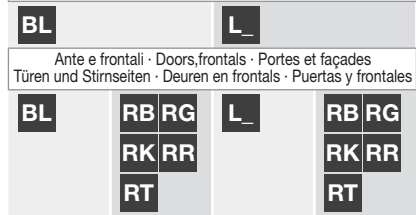

W D H
cm cm cm
in in in

Cod.

Kg m³
LB ft³



2 coppie ante con serratura
Storage unit with 2 pair of doors with lock
Desserte avec 2 paire portes avec serrure
Beistellmöbel mit 2 paar türen mit Schloss
Dressoir met 2 set deurtjes met slot
Aparador con 2 par de puertas con cerradura

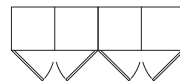
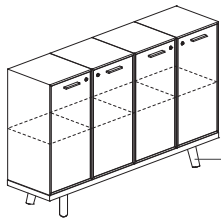

Aggiungere top obbligatorio
Add compulsory top
Ajouter le top obligatoire
Hinzufügen obligatorische Abdeckplatte
Toevoegen top binding
Añadir parte superior obligatorio

160,3 63 ³ / ₄ "	40 15 3/4"	102,5 40 1/4"	RC.1610.A0	2.028	2.584	3.292	3.608	110 243	0,74 26	+ 8,74
---	---------------	------------------	------------	-------	-------	-------	-------	------------	------------	--------

2 ante con serratura,4 vani a giorno
2 doors with lock,4 open compartments
2 portes avec serrure,4 logements à claire-voie
2 Türen mit Schloss,4 offene Fächer
2 deurtjes met slot,4 zichtbare ruimte
2 ante con cerradura,4 elemento abierto

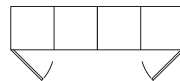
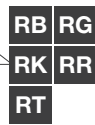
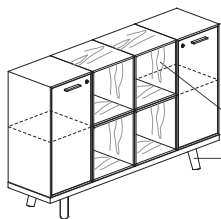

Aggiungere top obbligatorio
Add compulsory top
Ajouter le top obligatoire
Hinzufügen obligatorische Abdeckplatte
Toevoegen top binding
Añadir parte superior obligatorio

160,3 63 ³ / ₄ "	40 15 3/4"	102,5 40 1/4"	RC.1610.G4	2.814	3.092	3.494	3.652	109 239	0,76 27	+ 8,59
---	---------------	------------------	------------	-------	-------	-------	-------	------------	------------	--------

Top
Top
Top
Top
Topblad
Parte superior

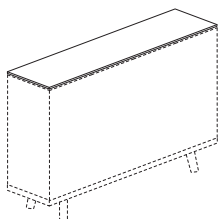

Finitura · Finish · Finition
Ausführung · Afwerking · Acabado



160,6 63 1/4"	40 15 3/4"	1,2 0 3/4"	RT.1604.00	71	204	270	1.165	5 12	0,03 1	+ 0,42
------------------	---------------	---------------	------------	----	-----	-----	-------	---------	-----------	--------

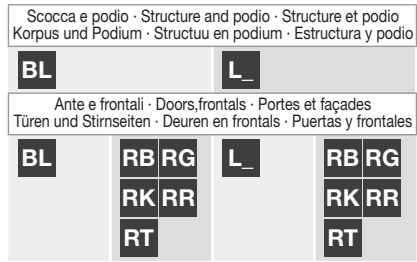

W D H
cm cm cm
in in in

Cod.

Kg LB m³ ft³



2 ante a ribalta con serratura,1 vano a giorno
2 drop-leaf doors with lock,1 open compartment
2 portes escamotable avec serrure,1 logement à claire-voie
2 Klapptüren mit Schloss,1 offene Fläche
2 bovenklapdeuren met slot,1 zichtbare ruimte
2 puertas basculante con cerradura,1 elemento abierto

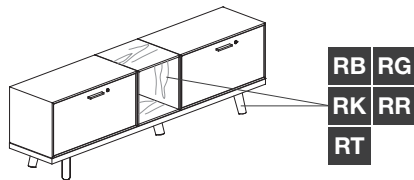

Aggiungere top obbligatorio
Add compulsory top
Ajouter le top obligatoire
Hinzufügen obligatorische Abdeckplatte
Toevoegen top binding
Añadir parte superior obligatorio

200,6 79"	40 15 3/4"	62,5 24 3/4"	RC.2006.RG	2.192	2.470	2.900	3.058	82 182	0,51 18	+ 6,38
--------------	---------------	-----------------	------------	-------	-------	-------	-------	-----------	------------	--------

2 ante a ribalta con serratura,2 estraibili con serratura,2 vani a giorno
2 drop-leaf doors with lock,2 extractables with lock,2 open compartments
2 portes escamotable avec serrure,2 extractibles avec serrure,2 logements à claire-voie
2 Klapptüren mit Schloss,2 abnehmbare mit Schloss,2 offene Fächer
2 bovenklapdeuren met slot,2 extraheerbare met slot,2 zichtbare ruimte
2 puertas basculante con cerradura,2 extraibles con cerradura,2 elemento abierto

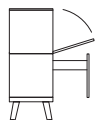
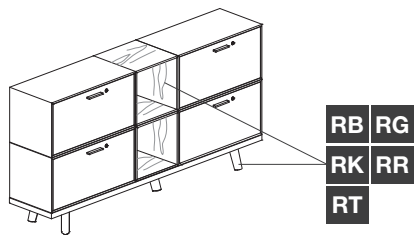

Aggiungere top obbligatorio
Add compulsory top
Ajouter le top obligatoire
Hinzufügen obligatorische Abdeckplatte
Toevoegen top binding
Añadir parte superior obligatorio

200,6 79"	40 15 3/4"	102,5 40 1/4"	RC.2010.RG	3.577	4.133	4.865	5.183	146 321	0,97 34	+ 11,23
--------------	---------------	------------------	------------	-------	-------	-------	-------	------------	------------	---------

Credenze · Storage units · Desserte
Beistellmöbel · Dressoir · Aparador

Scocca e podio · Structure and podio · Structure et podio
Korpus und Podium · Structuu en podium · Estructura y podio

BL	L_
Ante e frontali · Doors,frontals · Portes et façades Türen und Stirnseiten · Deuren en frontals · Puertas y frontales	
BL	RB RG
	RK RR
	RT
L_	RB RG
	RK RR
	RT

W D H
cm cm cm
in in in

Cod.

Kg LB m³ ft³



4	4	4	4
---	---	---	---

2 coppie ante con serratura,1 anta dx con serratura
2 pair of doors with lock,1 door Rh with lock
2 paire portes avec serrure,1 porte droite avec serrure
2 paar Türen mit Schloss,1 recht Tür mit Schloss
2 set deurtjes met slot,1 deur rechts met slot
2 par de puertas con cerradura,1 puerta derecha con cerradura

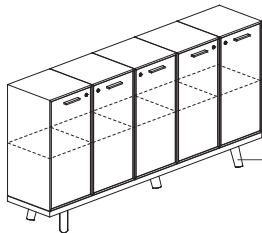

RB	RG
RK	RR
RT	

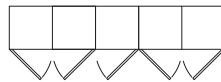

Aggiungere top obbligatorio
Add compulsory top
Ajouter le top obligatoire
Hinzufügen obligatorische Abdeckplatte
Toevoegen top binding
Añadir parte superior obligatorio

200,6 79"	40 15 3/4"	102,5 40 1/4"	RC.2010.A0	2.526	3.221	4.112	4.507	138 305	0,92 33	+ 10,95
--------------	---------------	------------------	------------	-------	-------	-------	-------	------------	------------	---------

2 coppie ante con serratura,2 vani a giorno
2 pair of doors with lock,2 open compartments
2 paire portes avec serrure,2 logements à claire-voie
2 paar Türen mit Schloss,2 offene Fächer
2 set deurtjes met slot,2 zichtbare ruimte
2 par de puertas con cerradura,2 elemento abierto

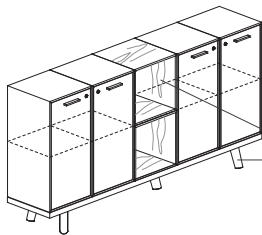

RB	RG
RK	RR
RT	

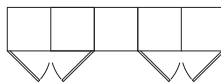

Aggiungere top obbligatorio
Add compulsory top
Ajouter le top obligatoire
Hinzufügen obligatorische Abdeckplatte
Toevoegen top binding
Añadir parte superior obligatorio

200,6 79"	40 15 3/4"	102,5 40 1/4"	RC.2010.G2	2.919	3.475	4.213	4.529	137 303	0,93 33	+ 10,88
--------------	---------------	------------------	------------	-------	-------	-------	-------	------------	------------	---------

Top
Top
Top
Top
Topblad
Parte superior

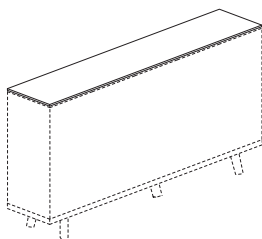

Finitura · Finish · Finition
Ausführung · Afwerking · Acabado

BL	L_	RB RG	EB EG
		RK RR	EK
		RT	

4	4	4	6
---	---	---	---

200,7 79"	40 15 3/4"	1,2 0 3/4"	RT.2004.00	83	245	335	1.345	7 15	0,04 1	+ 0,52
--------------	---------------	---------------	------------	----	-----	-----	-------	---------	-----------	--------

Credenze · Storage units · Desserte
Beistellmöbel · Dressoir · Aparador

Scocca e podio · Structure and podio · Structure et podio
Korpus und Podium · Structuu en podium · Estructura y podio

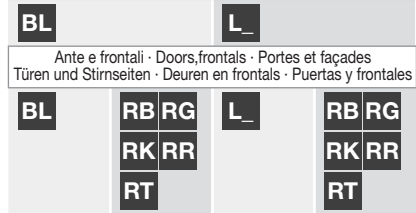

W D H
cm cm cm
in in in

Cod.

Kg LB m³ ft³



2 ante a ribalta con serratura, 2 vani a giorno
2 drop-leaf doors with lock, 2 open compartments
2 portes escamotable avec serrure, 2 logements à claire-voie
2 Klapptüren mit Schloss, 2 offene Fächer
2 bovenklapdeuren met slot, 2 zichtbare ruimte
2 puertas basculante con cerradura, 2 elemento abierto

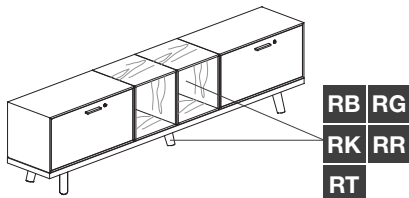

Aggiungere top obbligatorio
Add compulsory top
Ajouter le top obligatoire
Hinzufügen obligatorische Abdeckplatte
Toevoegen top binding
Añadir parte superior obligatorio

240,9 94 3/4"	40 15 3/4"	62,5 24 3/4"	RC.2406.RG	2.574	2.852	3.336	3.494	98 215	0,62 22	+ 7,59
------------------	---------------	-----------------	------------	-------	-------	-------	-------	-----------	------------	--------

2 ante a ribalta con serratura, 2 cassetti con serratura
2 drop-leaf doors with lock, 2 drawers with lock
2 portes escamotable avec serrure, 2 tiroirs avec serrure
2 Klapptüren mit Schloss, 2 Schubladen mit Schloss
2 bovenklapdeuren met slot, 2 lades met slot
2 puertas basculante con cerradura, 2 cajones con cerradura

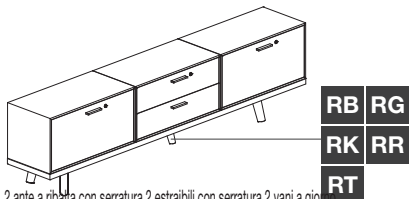

Aggiungere top obbligatorio
Add compulsory top
Ajouter le top obligatoire
Hinzufügen obligatorische Abdeckplatte
Toevoegen top binding
Añadir parte superior obligatorio

240,9 94 3/4"	40 15 3/4"	62,5 24 3/4"	RC.2406.E2	2.503	2.922	3.495	3.732	109 239	0,61 22	+ 8,45
------------------	---------------	-----------------	------------	-------	-------	-------	-------	------------	------------	--------

2 ante a ribalta con serratura, 2 estraibili con serratura, 2 vani a giorno
2 drop-leaf doors with lock, 2 extractables with lock, 4 open compartments
2 portes escamotable avec serrure, 2 extractibles avec serrure, 4 logements à claire-voie
2 Klapptüren mit Schloss, 2 abnehmbare mit Schloss, 4 offene Fächer
2 bovenklapdeuren met slot, 2 extraheerbare met slot, 4 zichtbare ruimte
2 puertas basculante con cerradura, 2 extraibles con cerradura, 4 elemento abierto

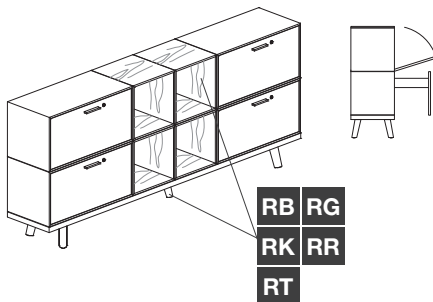

Aggiungere top obbligatorio
Add compulsory top
Ajouter le top obligatoire
Hinzufügen obligatorische Abdeckplatte
Toevoegen top binding
Añadir parte superior obligatorio

240,9 94 3/4"	40 15 3/4"	102,5 40 1/4"	RC.2410.RG	4.336	4.892	5.678	5.996	172 379	1,16 41	+ 13,31
------------------	---------------	------------------	------------	-------	-------	-------	-------	------------	------------	---------

Credenze · Storage units · Desserte
Beistellmöbel · Dressoir · Aparador

Scocca e podio · Structure and podio · Structure et podio
Korpus und Podium · Structuu en podium · Estructura y podio

BL			L_		
Ante e frontali · Doors,frontals · Portes et façades Türen und Stirnseiten · Deuren en frontals · Puertas y frontales					
BL	RB	RG	L_	RB	RG
	RK	RR		RK	RR
	RT			RT	

W D H
cm cm cm
in in in

Kg m³
LB ft³



4	4	4	4
---	---	---	---

3 coppie ante con serratura
Storage unit with 3 pair of doors with lock
Desserte avec 3 paire portes avec serrure
Beistellmöbel mit 3 paar türen mit Schloss
Dressoir met 3 set deurtes met slot
Aparador con 3 par de puertas con cerradura

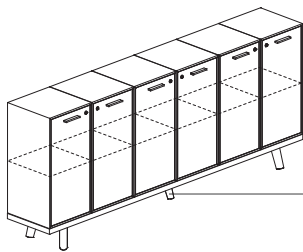

RB	RG
RK	RR
RT	

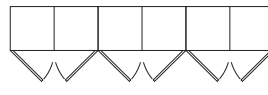

Aggiungere top obbligatorio
Add compulsory top
Ajouter le top obligatoire
Hinzufügen obligatorische Abdeckplatte
Toevoegen top binding
Añadir parte superior obligatorio

240,9	40	102,5	RC.2410.A0	2.892	3.726	4.824	5.298	166	1,11	+ 13,11
94 3/4"	15 3/4"	40 1/4"						365	39	

2 coppie ante con serratura,4 vani a giorno
2 pair of doors with lock,4 open compartments
2 paire portes avec serrure,4 logements à claire-voie
2 paar Türen mit Schloss,4 offene Fächer
2 set deurtes met slot,4 zichtbare ruimte
2 par de puertas con cerradura,4 elemento abierto

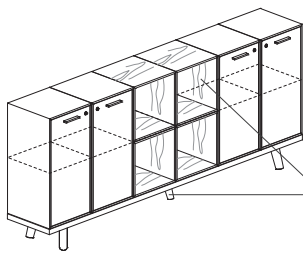

RB	RG
RK	RR
RT	

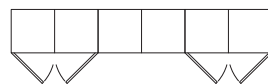

Aggiungere top obbligatorio
Add compulsory top
Ajouter le top obligatoire
Hinzufügen obligatorische Abdeckplatte
Toevoegen top binding
Añadir parte superior obligatorio

240,9	40	102,5	RC.2410.G4	3.678	4.234	5.026	5.342	164	1,13	+ 12,97
94 3/4"	15 3/4"	40 1/4"						361	40	

Top
Top
Top
Top
Topblad
Parte superior

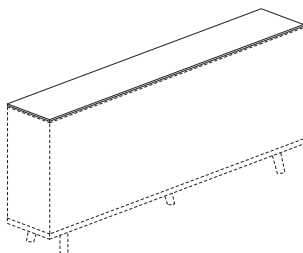

Finitura · Finish · Finition
Ausführung · Afwerking · Acabado

BL	L_	RB	RG	EB	EG
		RK	RR	EK	
		RT			
4	4	4	6		

240,9	40	1,2	RT.2404.00	97	286	401	1.717	8	0,04	+ 0,63
94 3/4"	15 3/4"	0 3/4"						18	1	