

Gambe · Legs · Piètements Beine · Patas							
RB	RC	RG	RK	RR	RT	RU	
Piano · Worktop · Plateau Tischplatte · Plano							
RB	RC	RG	RK	CK	VG		
RR	RT	RU					

W D H
cm cm cm Cod.

Kg m³



4 weeks

4 weeks

Scrivania
Desk
Bureau
Schreibtisch
Escritorio

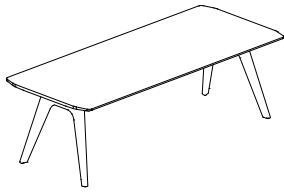

180	80	75	RS.1808.00	3.251	3.448	56	0,28
200	100	75	RS.2010.00	3.505	3.720	70	0,32
220	100	75	RS.2210.00	3.643	3.896	76	0,34
240	100	75	RS.2410.00	3.781	4.074	82	0,36

Scrivania a ponte per aggancio al mobile di servizio
Bridge desk for hooking to service cabinet
Bureau pour fixation au meuble de service
Schreibtisch geeignet für Befestigung an Technikcontainer
Escritorio en puente con apoyo para mueble de servicio

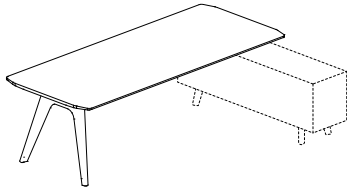

180	80	75	RS.1808.A0	2.756	2.805	51	0,21
200	100	75	RS.2010.A0	3.008	3.132	65	0,25
220	100	75	RS.2210.A0	3.146	3.369	71	0,27
240	100	75	RS.2410.A0	3.286	3.607	77	0,28

Scrivania a ponte per aggancio al mobile di servizio
Bridge desk for hooking to service cabinet
Bureau pour fixation au meuble de service
Schreibtisch geeignet für Befestigung an Technikcontainer
Escritorio en puente con apoyo para mueble de servicio

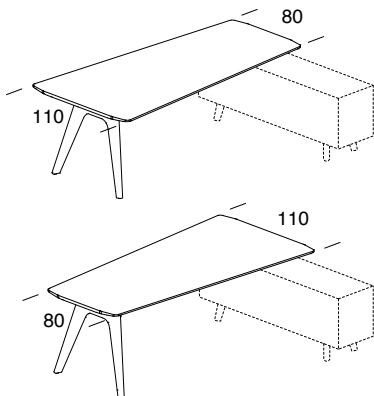

220	110	75	RS.2210.AC	3.366	3.578	74	0,28
------------	-----	----	-------------------	--------------	--------------	----	------

Scocca e podio · Structure and podium · Structure et podio
 Korpus und Podium · Estructura y podio

BL	MK			L_			
Ante e frontali · Doors and frontals · Portes et façades Türen und Fronten · Puertas y frontales							
BL	MK	RB	RC	L_	RB	RC	
		RG	RK			RG	RK
		RR	RT			RR	RT
		RU			RU		

W D H
 cm cm cm Cod.

Kg m³



++++ weeks 4	++++ weeks 4	++++ weeks 4	++++ weeks 4
--------------------	--------------------	--------------------	--------------------

2 cassetti con serratura, 1 modulo tecnico, 1 cestello portacavi
 2 drawers with lock, 1 technical module, 1 cable holder baskets
 2 tiroirs avec serrure, 1 module technique, 1 panier porte-câbles
 2 Schubladen mit Schloss, 1 CPU Modul, 1 Kabelwanne
 2 cajones con cerradura, 1 módulo técnico, 1 bandeja portacables

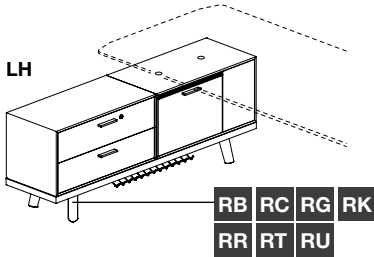

Aggiungere top RT.1604.SE
 Add top RT.1604.SE
 Ajouter le top RT.1604.SE
 Abdeckplatte RT.1604.SE Hinzufügen
 Añadir parte superior RT.1604.SE

RH	160,3	40	62,5	RL.1606.D2	2.503	2.764	3.439	3.546	80	0,42
LH	160,3	40	62,5	RL.1606.S2	2.503	2.764	3.439	3.546	80	0,42

1 anta e 2 cassetti, 2 serrature, 1 modulo tecnico, 2 cestelli portacavi
 1 door and 2 drawers, 2 locks, 1 technical module, 2 cable holder baskets
 1 porte et 2 tiroirs, 2 serrures, 1 module technique, 2 paniers porte-câbles
 1 Tür und 2 Schubladen mit Schloss, 1 CPU Modul, 2 Kabelwanne
 1 puerta y 2 cajones, 2 cerraduras, 1 módulo técnico, 2 bandejas portacables

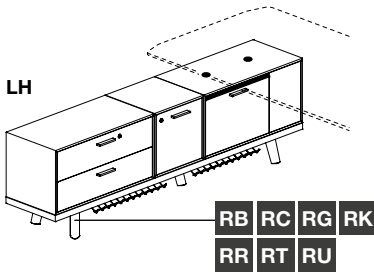

Aggiungere top RT.2004.SE
 Add top RT.2004.SE
 Ajouter le top RT.2004.SE
 Abdeckplatte RT.2004.SE Hinzufügen
 Añadir parte superior RT.2004.SE

RH	200,6	40	62,5	RL.2006.D2	3.113	3.449	4.342	4.477	99	0,53
LH	200,6	40	62,5	RL.2006.S2	3.113	3.449	4.342	4.477	99	0,53

Top con predisposizione per scrivania dx o sx
 Top with arrangement for desk Rh or Lh
 Top avec prédisposition pour bureau droite ou gauche
 Abdeckplatte mit vorbereitung für Schreibtische RE oder LI
 Plano superior con la disposición para escritorio derecho o izquierdo

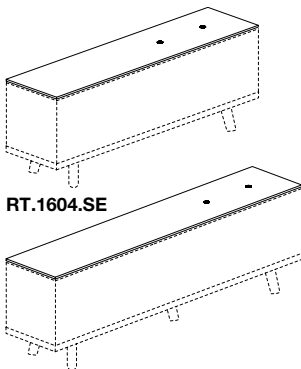

Finitura · Finish · Finition Ausführung · Acabado							
BL	MK			L_			
		RB	RC			RB	RC
		RG	RK			RG	RK
		RR	RT			RR	RT
		RU			RU		

++++ weeks 4	++++ weeks 4	++++ weeks 4
--------------------	--------------------	--------------------

	160,6	40	1,2	RT.1604.SE	85	252	323	5	0,03
	200,7	40	1,2	RT.2004.SE	98	302	400	7	0,04

Scocca e podio · Structure and podium · Structure et podio
 Kopus und Podium · Estructura y podio

BL	MK			L_			
Ante e frontali · Doors and frontals · Portes et façades Türen und Fronten · Puertas y frontales							
BL	MK	RB	RC	L_	RB	RC	
		RG	RK			RG	RK
		RR	RT			RR	RT
		RU			RU		

W D H
 cm cm cm Cod.

Kg m³



4 weeks	4 weeks	4 weeks	4 weeks
---------	---------	---------	---------

2 ante con serratura, 1 modulo tecnico, 1 cestello portacavi
 2 doors with lock, 1 technical module, 1 cable holder baskets
 2 portes avec serrure, 1 module technique, 1 panier porte-câbles
 2 türen mit Schloss, 1 CPU Modul, 1 Kabelwanne
 2 puertas con cerradura, 1 módulo técnico 1 bandeja portacables

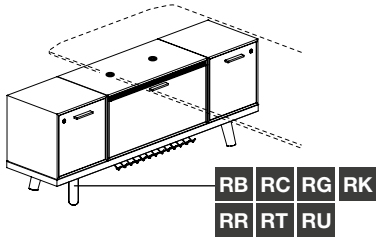

Aggiungere top RT.1604.SC
 Add top RT.1604.SC
 Ajouter le top RT.1604.SC
 Abdeckplatte RT.1604.SC Hinzufügen
 Añadir parte superior RT.1604.SC

160,3	40	62,5	RL.1606.AR	2.406	2.678	3.565	3.671	69	0,42
-------	----	------	------------	-------	-------	-------	-------	----	------

2 ante ribalta, 2 serrature, 1 modulo tecnico, 2 cestelli portacavi
 2 drop-leaf doors, 2 locks, 1 technical module, 2 cable holder baskets
 2 portes escamotables, 2 serrures, 1 module technique, 2 paniers porte-câbles
 2 Klapptüren mit Schloss, 1 CPU Modul, 2 Kabelwanne
 2 puertas basculante, 2 cerraduras, 1 módulo técnico, 2 bandeja portacables

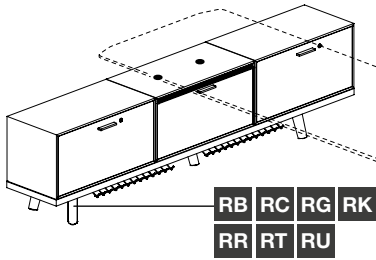

Aggiungere top RT.2404.SC
 Add top RT.2404.SC
 Ajouter le top RT.2404.SC
 Abdeckplatte RT.2404.SC Hinzufügen
 Añadir parte superior RT.2404.SC

240,9	40	62,5	RL.2406.R3	3.278	3.686	4.728	4.900	101	0,63
-------	----	------	------------	-------	-------	-------	-------	-----	------

Top con predisposizione per scrivania centrale al mobile di servizio
 Top with arrangement for central desk to the service module
 Top avec prédisposition pour bureau central sur meuble de service
 Abdeckplatte mit vorbereitung für zentral Schreibtische zum Technikcontainer
 Plano superior con la disposición para escritorio central al mueble de servicio

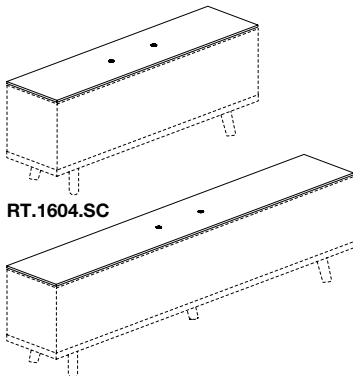

RT.1604.SC

RT.2404.SC

Finitura · Finish · Finition Ausführung · Acabado							
BL	MK			L_	RB	RC	
		RG	RK			RG	RK
		RR	RT			RR	RT
		RU			RU		

4 weeks	4 weeks	4 weeks
---------	---------	---------

160,6	40	1,2	RT.1604.SC	85	252	323	5	0,03
240,9	40	1,2	RT.2404.SC	115	353	479	8	0,04

Finitura · Finish · Finition
Ausführung · Acabado

RB RC RG RK RR RT RU

W D H
cm cm cm Cod.

Kg m³



++++
weeks
4

Gonna H.28
Modesty panel H.28
Voile de fond H.28
Knieraumblende H.28
Faldón H.28

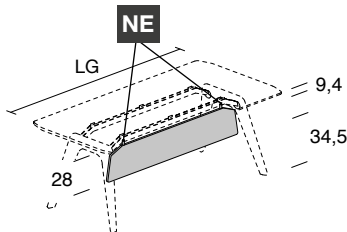

No per scrivanie con piani vetro
Not for desks with glass top
Ne pas utiliser pour des bureaux avec plateau en verre
Nicht für Schreibtische mit glas Tischplatte
No para mesas con tapas de vidrio

LG	W	D	H	Cod.	Price	Weight (Kg)	Volume (m³)
180	132	1,9	28	RG.1303.00	458	6	0,01
200	152	1,9	28	RG.1503.00	477	6	0,01
220	172	1,9	28	RG.1703.00	495	7	0,01
240	192	1,9	28	RG.1903.00	512	8	0,01

Gonna per scrivania a ponte H.28
Modesty panel for bridge desk H.28
Voile de fond pour bureau en pont H.28
Knieraumblende H. 28 für tisch geeignet für Befestigung zum Technikcontainer
Faldón H.28 para escritorio en puente

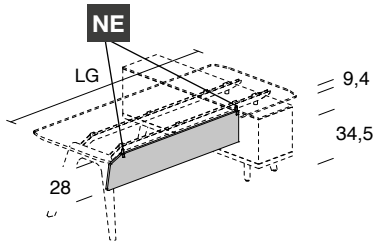

No per scrivanie con piani vetro
Not for desks with glass top
Ne pas utiliser pour des bureaux avec plateau en verre
Nicht für Schreibtische mit glas Tischplatte
No para mesas con tapas de vidrio

LG	W	D	H	Cod.	Price	Weight (Kg)	Volume (m³)
180	115	1,9	28	RG.1203.00	428	5	0,01
200	135	1,9	28	RG.1403.00	446	6	0,01
220	155	1,9	28	RG.1603.00	464	7	0,01
240	175	1,9	28	RG.1803.00	483	7	0,01

Sottomano
Desk pad
Sous-main
Schreibunterlage
Vade

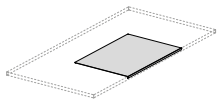

Finitura · Finish · Finition
Ausführung · Acabado

PL1

PE1

++++
weeks
4

++++
weeks
4

W	D	H	Cod.	Price	Weight (Kg)	Volume (m³)
70	50	2	CZ.0705.00	329	286	7 0,02

Appendiabiti
Coathanger
Porte-manteaux
Kleiderstange
Perchas para ropa

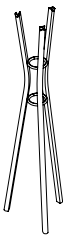

Finitura · Finish · Finition
Ausführung · Acabado

RB RC RG RK RR RT RU R2 R4

++++
weeks
4

W	D	H	Cod.	Price	Weight (Kg)	Volume (m³)
45	45	160	CZ.0164.01	551	5 0,02	

Scocca e podio · Structure and podium · Structure et podio
 Korpuz und Podium · Estructura y podio

BL MK

L_

Ante e frontali · Doors and frontals · Portes et façades
 Türen und Fronten · Puertas y frontales

BL MK

RB RC

L_

RB RC

RG RK

RG RK

RR RT

RR RT

RU

RU

W D H
 cm cm cm Cod.

Kg m³



Mobile con 2 cassetti, 1 serratura
 Service module with 2 drawers, 1 lock
 Meuble de service avec 2 tiroirs, 1 serrure
 Technikcontainer mit 2 Schubladen, 1 Schloss
 Módulos de servicio con 2 cajones, 1 cerradura

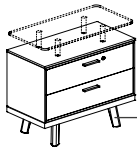

RB RC RG RK
 RR RT RU

Aggiungere top RT.0804.01
 Add top RT.0804.01
 Ajouter le top RT.0804.01
 Abdeckplatte RT.0804.01 Hinzufügen
 Añadir parte superior RT.0804.01

80	40	62,8	RC.0804.NO	1.512	1.651	1.979	2.036	47	0,22
----	----	------	------------	-------	-------	-------	-------	----	------

Mobile con 1 anta e 2 cassetti, 2 serrature
 Service module with 1 door and 2 drawers, 2 locks
 Meuble de service avec 1 porte et 2 tiroirs, 2 serrures
 Technikcontainer mit 1 Tür und 2 Schubladen, 2 Schlösser
 Módulos de servicio con 1 puerta y 2 cajones, 2 cerraduras

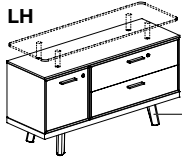

RB RC RG RK
 RR RT RU

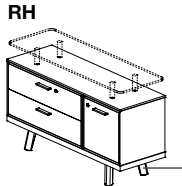

RB RC RG RK
 RR RT RU

Aggiungere top RT.1204.01
 Add top RT.1204.01
 Ajouter le top RT.1204.01
 Abdeckplatte RT.1204.01 Hinzufügen
 Añadir parte superior RT.1204.01

RH	120,3	40	62,8	RC.1204.NR	1.934	2.148	2.713	2.798	66	0,33
LH	120,3	40	62,8	RC.1204.NL	1.934	2.148	2.713	2.798	66	0,33

Top
 Top
 Top
 Abdeckplatte
 Parte superior

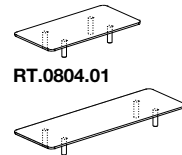

RT.0804.01

RT.1204.01

Finitura · Finish · Finition
 Ausführung · Acabado

RB RC RG RK

CK VG

RR RT RU

4 weeks

4 weeks

80	40	12,7	RT.0804.01	592	592	10	0,05
120	40	12,7	RT.1204.01	668	668	13	0,06

		Gambe · Legs · Piètements Beine · Patas		Piano · Worktop · Plateau Tischplatte · Plano							
		RB	RC	RG	RK	RR	RT	RU			
		RB	RC	PL1		PE1					
		RG	RK								
		RR	RT								
		RU									
		W cm		D cm	H cm	Cod.			Kg	m³	
<p>Tavolino basso Low table Petite table basse Niedriger Tisch Mesita baja</p>		60	60	40	RT.0606.00	1.014	-	-	11	0,04	
		120	60	40	RT.1206.00	1.221	-	-	19	0,06	
<p>Tavolo rotondo (4 posti) Round table (4 seater) Table ronde (4 places) Rundtisch (4 Personen) Mesa redonda (4 puestos)</p>		120	120	75	RT.D120.00	2.200	-	-	41	0,32	
<p>RT.D120.00 RT.D120.V0</p>											
		120	120	75	RT.D120.V0	2.466	-	-	42	0,33	
<p>Tavolo rotondo 3 piani (6 posti) Round table 3 tops (6 seater) Table ronde 3 plateaux (6 places) Rundtisch 3 Tischplatte (6 Personen) Mesa redonda 3 planos (6 puestos)</p>		160	160	75	RT.D160.00	4.521	5.220	4.800	99	0,63	
<p>RT.D160.00 RT.D160.V3</p>											
		160	160	75	RT.D160.V3	4.788	5.487	5.067	100	0,64	
<p>Scrivania-Tavolo triangolare 3 piani (6 posti) Desk-Triangular table 3 tops (6 seater) Bureau-Table triangulaire 3 plateaux (6 places) Dreieckiger Tisch 3 platten (6 Personen) Escritorio-Mesa triangular 3 planos (6 puestos)</p>		179,4	171,6	75	RT.1616.T3	5.433	6.177	5.781	106	0,65	
<p>RT.1616.T3 RT.1616.TV</p>											
		179,4	171,6	75	RT.1616.TV	5.700	6.444	6.048	107	0,66	
<p>Scrivania-Tavolo triangolare 2 piani legno, 1 rivestito in pelle (6 posti) Desk-Triangular table 2 wooden tops, 1 covered in leather (6 seater) Bureau-Table triangulaire 2 plateaux en bois, 1 revêtu en cuir (6 places) Dreieckiger Tisch 2 Holzplatten, 1 Leder-bezogen (6 Personen) Escritorio-Mesa triangular 2 planos de madera, 1 revestido de piel (6 puestos)</p>		179,4	171,6	75	RT.1616.P3	-	5.681	5.549	101	0,65	
<p>RT.1616.P3 RT.1616.PV</p>											
		179,4	171,6	75	RT.1616.PV	-	5.948	5.816	102	0,66	

Gambe · Legs · Piètements Beine · Patas						
RB	RC	RG	RK	RR	RT	RU
Piano · Worktop · Plateau Beine · Plano						
RB	RC	RG	RK	RR	RT	RU

W D H
cm cm cm Cod.

Kg m³



++++
weeks
4

Tavolo sagomato (8/10 posti)
Shaped table (8/10 seater)
Table tonneau (8/10 places)
Geformter Tisch (8/10 Personen)
Mesa perfilado (8/10 puestos)

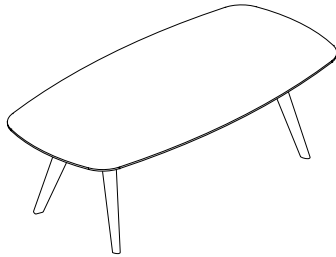

RT.2412.00
RT.2812.00

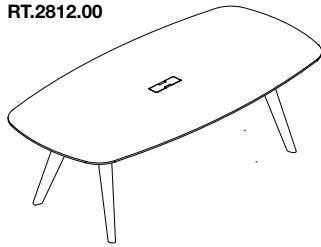

RT.2412.V0
RT.2812.V0

240	120	75	RT.2412.00	3.974	87 0,38
280	120	75	RT.2812.00	4.452	100 0,42

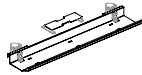

Top access e vaschetta compresi
Top-access and wire tray included
Top Access et portillon inclus
Inklusiv Kabelklappe und Kabelwanne
Acceso superior y puerta incluida

240	120	75	RT.2412.V0	4.268	90 0,4
280	120	75	RT.2812.V0	4.745	103 0,44

Tavolo sagomato (12/16 posti)
Shaped table (12/16 seater)
Table tonneau (12/16 places)
Geformter Tisch (12/16 Personen)
Mesa perfilado (12/16 puestos)

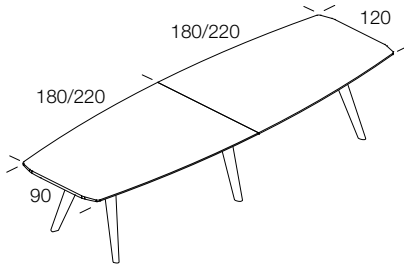

RT.3612.00
RT.4412.00

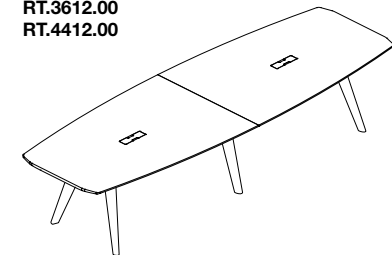

RT.3612.V2
RT.4412.V2

360	120	75	RT.3612.00	6.722	129 0,76
440	120	75	RT.4412.00	7.836	165 0,83

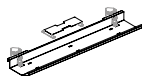

2 top access e 2 vaschette compresi
2 top-access and 2 wire trays included
2 Top Access et 2 portillons inclus
Inklusiv 2 Kabelklappe und 2 Kabelwanne
2 acceso superior y 2 puertas incluida

360	120	75	RT.3612.V2	7.308	135 0,81
440	120	75	RT.4412.V2	8.368	171 0,88

Gambe · Legs · Piètements Beine · Patas						
RB	RC	RG	RK	RR	RT	RU
Piano · Worktop · Plateau Tischplatte · Plano						
RB	RC	RG	RK	RR	RT	RU

W D H
cm cm cm Cod.

Kg m³



++++
weeks
4

Tavolo sagomato (8 posti)
Shaped table (8 seater)
Table tonneau (8 places)
Geformter Tisch (8 Personen)
Mesa perfilado (8 puestos)

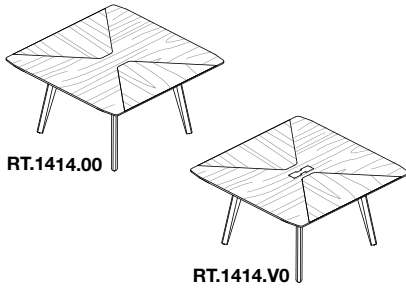

140	140	75	RT.1414.00	4.169	90	0,22
				 <p>Top access e vaschetta compresi Top-access and wire tray included Top Access et portillon inclus Inklusiv Kabelklappe und Kabelwanne Acceso superior y puerta incluida</p>		
140	140	75	RT.1414.V0		4.436	91

Tavolo sagomato (12 posti)
Shaped table (12 seater)
Table tonneau (12 places)
Geformter Tisch (12 Personen)
Mesa perfilado (12 puestos)

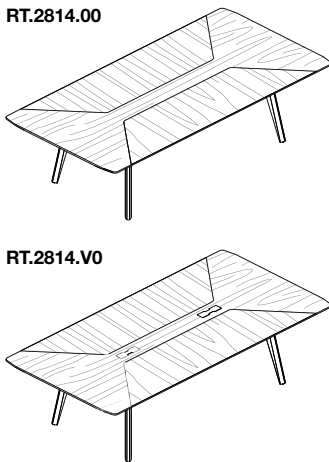

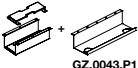
280	140	75	RT.2814.00	8.087	171	0,32
				 <p>2 top access e 2 vaschette compresi 2 top-access and 2 wire trays included 2 Top Access et 2 portillons inclus Inklusiv 2 Kabelklappe und 2 Kabelwanne 2 acceso superior y 2 puertas incluida</p>		
280	140	75	RT.2814.V0		8.657	176

H. 105 cm

Gambe · Legs · Piètements
Beine · Patas

RB RC RG RK RR RT RU

Piano · Worktop · Plateau
Tischplatte · Plano

RB RC RG RK RR RT RU

W D H
cm cm cm Cod.

Kg m³



weeks

++++
weeks
4

Tavolo sagomato (8 posti)
Shaped table (8 seater)
Table tonneau (8 places)
Geformter Tisch (8 Personen)
Mesa perfilado (8 puestos)

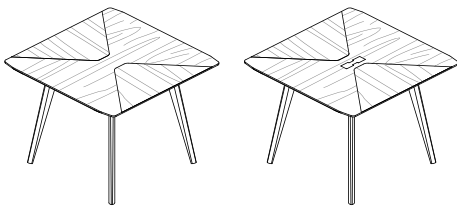

RT.1414.11

RT.1414.1V



140 140 105

RT.1414.11

4.421

94 0,23

Top access e vaschetta compresi
Top-access and wire tray included
Top Access et portillon inclus
Inklusiv Kabelklappe und Kabelwanne
Acceso superior y puerta incluida

Tavolo sagomato (12 posti)
Shaped table (12 seater)
Table tonneau (12 places)
Geformter Tisch (12 Personen)
Mesa perfilado (12 puestos)

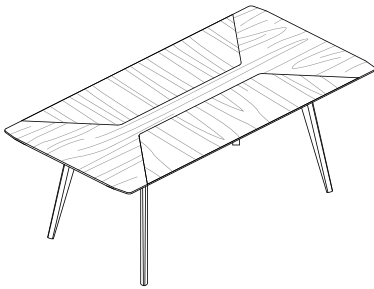

RT.2814.11

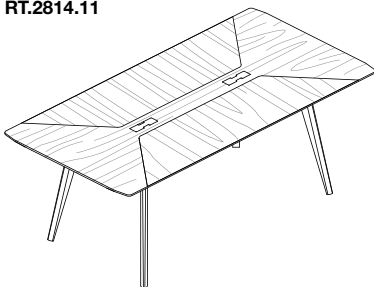

RT.2814.1V

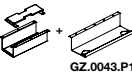

280 140 105

RT.2814.11

8.339

175 0,32

2 top access e 2 vaschette compresi
2 top-access and 2 wire trays included
2 Top Access et 2 portillons inclus
Inklusiv 2 Kabelklappe und 2 Kabelwanne
2 acceso superior y 2 puertas incluida

280 140 105

RT.2814.1V

8.909

180 0,36

Gambe · Legs · Piètements
Beine · Patas

RB RC RG RK RR RT RU

Piano · Worktop · Plateau
Tischplatte · Plano

CK VG

W D H
cm cm cm Cod.

Kg m³



weeks

++++
weeks
4

Tavolo rotondo (4 posti)
Round table (4 seater)
Table ronde (4 places)
Rundtisch (4 Personen)
Mesa redonda (4 puestos)

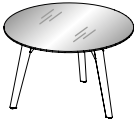

120 120 75 **RV.D120.00** **2.514** 60 0,32

Tavolo rotondo (6 posti)
Round table (6 seater)
Table ronde (6 places)
Rundtisch (6 Personen)
Mesa redonda (6 puestos)

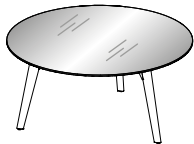

160 160 75 **RV.D160.00** **4.461** 107 0,65

Tavolo triangolare (6 posti)
Triangular table (6 seater)
Table triangulaire (6 places)
Dreieckiger Tisch (6 Personen)
Mesa triangular (6 puestos)

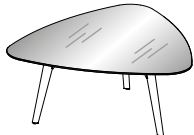

179,4 171,6 75 **RV.1616.00** **5.173** 148 0,7

Tavolo sagomato (8 posti)
Shaped table (8 seater)
Table tonneau (8 places)
Geformter Tisch (8 Personen)
Mesa con forma (8 puestos)

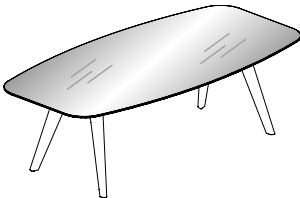

240 120 75 **RV.2412.00** **4.165** 136 0,45

Finitura · Finish · Finition
Ausführung · Acabado

KR

W D H Cod.
cm cm cm

Kg m²



++++
weeks
4

Posizione su richiesta dei fori passacavi
Position regarding request for holes cable
Sur demande position des trous de passage des câbles
Positionierung der Löcher für Hole Kabel auf anfrage
Posición a petición de los oricios para pasacables

Tappo passacavi in metallo per piani legno e pelle
Metal grommet cable holder for wooden or leather tops
Passe câbles en métal pour plateaux en bois et cuir
Metall Kabeldurchlass für Holz und Leder Tischplatte
Tapas pasacables en metal para plano de madera o de piel

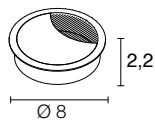
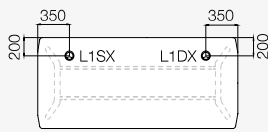

8	8	2,2	RZ.0008.AO	29	0	0
---	---	-----	-------------------	-----------	---	---

Con applicazione · With application · Avec perçage
Mit Anwendung · Con aplicación

8	8	2,2	RZ.0008.00	65	0	0
---	---	-----	-------------------	-----------	---	---

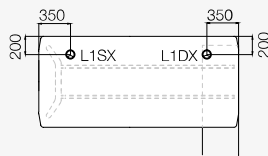

Tappo passacavi in metallo per piani vetro
Metal grommet cable holder for glass tops
Passe câbles en métal pour plateaux en verre
Metall Kabeldurchlass für Glass Tischplatte
Tapas pasacables en metal para tapas de vidrio

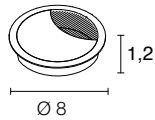
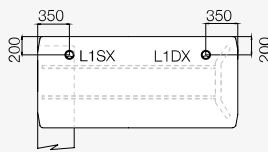

8	8	1,2	RZ.0008.VO	29	0	0
---	---	-----	-------------------	-----------	---	---

Con applicazione · With application · Avec perçage
Mit Anwendung · Con aplicación

8	8	1,2	RZ.0008.AV	125	0	0
---	---	-----	-------------------	------------	---	---

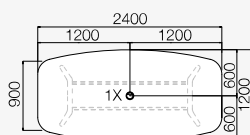
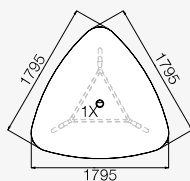
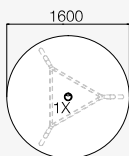
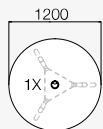
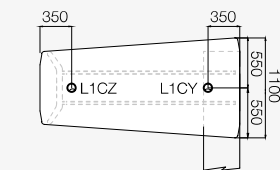
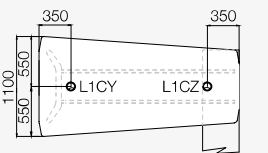

Finitura · Finish · Finition
Ausführung · Acabado

NE

W D H
cm cm cm Cod.

Kg m³



4 weeks

Blocco portaprese + cavo di alimentazione L.200cm
 Socket holder +1 power cord W.200cm
 Boîtes de prises+1 cordon d'alimentation L.200cm
 Steckdosenblock +Netzkaebel 1xB.200
 Bloque para enchufe + 1 cable de alimentación A.200cm

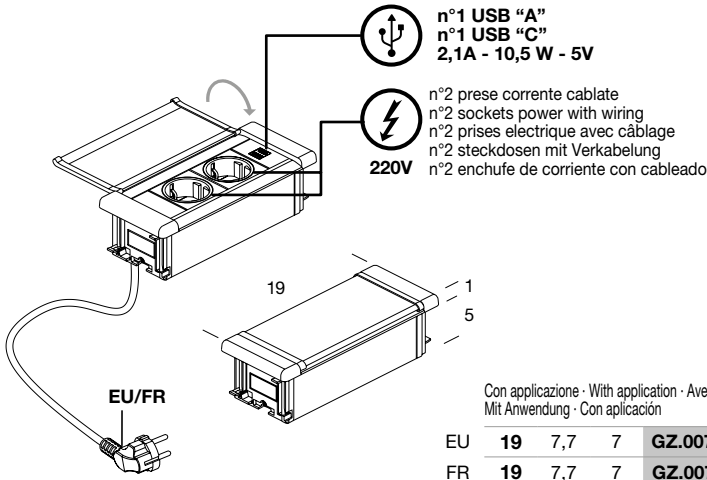

Con applicazione · With application · Avec perçage
Mit Anwendung · Con aplicación

EU	19	7,7	7	GZ.0079.EU	386	1	0,01
FR	19	7,7	7	GZ.0079.FR	386	1	0,01

Posizione su richiesta dei fori passacavi
 Position regarding request for holes cable · Sur demande position des trous de passage des câbles
 Positionierung der löcher für Hole Kabel auf anfrage · Posición a petición de los oricios para pasacables

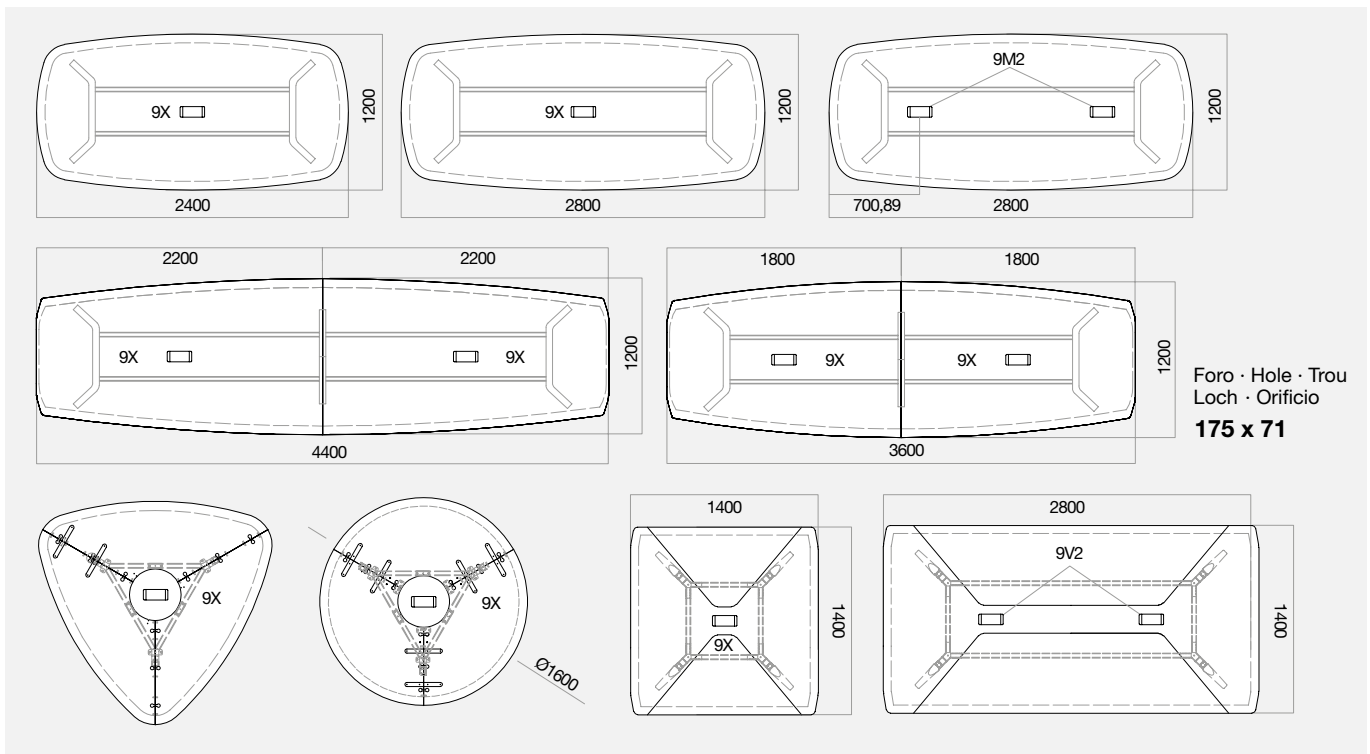

Finitura · Finish · Finition
Ausführung · Acabado

NE

W cm D cm H cm Cod.

Kg m³



6 weeks

Blocco portaprese Versaturn+cavo di alimentazione L.200cm
Foldway socket holder Versaturn+1 power cord W.200cm
Boîtier de prises Versaturn+1 câble d'alimentation L.200cm
Steckdosenblock Versaturn+Netzkaebel 1xL.200
Base de conexiones Versaturn+1 cable de alimentación A.200cm

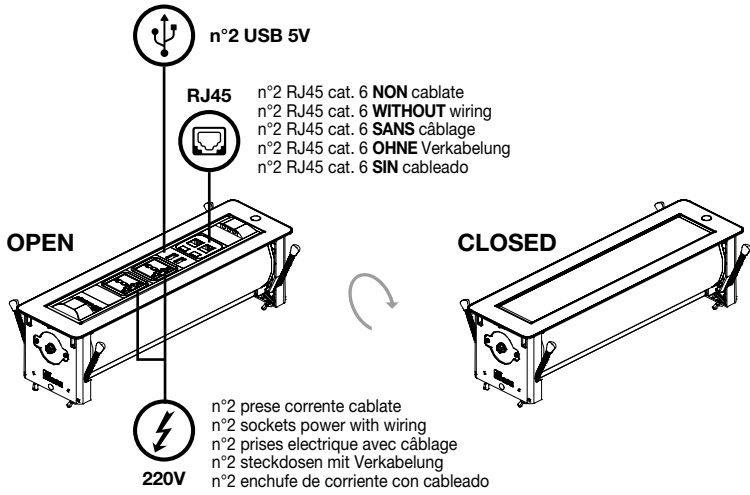

Con applicazione · With application · Avec perçage
Mit Anwendung · Con aplicación

EU	39	11,2	10,7	GZ.0039.EU	983	2	0,02
UK	39	11,2	10,7	GZ.0039.UK	983	2	0,02

Posizione su richiesta dei fori passacavi
Position regarding request for holes cable · Sur demande position des trous de passage des câbles
Positionierung der löcher für Hole Kabel auf anfrage · Posición a petición de los oricios para pasacables

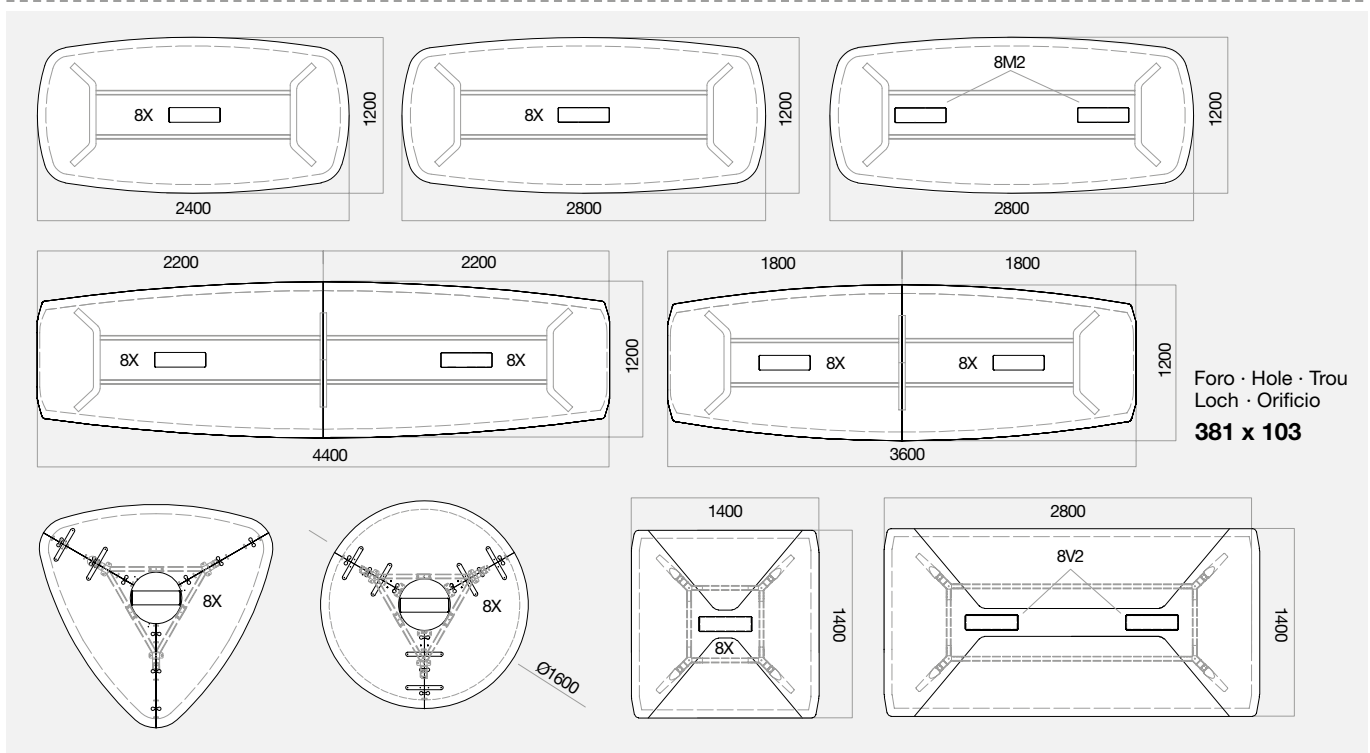

Finitura · Finish · Finition
Ausführung · Acabado

KR

W D H
cm cm cm Cod.

Kg m²



weeks

++++
weeks
2

Passacavi verticale con spazzola
Vertebra cable guide with brush strip and base
Vertèbre passe câbles avec brosse et base
Vertikale Elektrifizierung durch Kabelspirale KR
Vértebra pasacables con cepillo y base

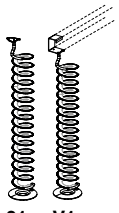

01 V1

Piano legno o pelle · Wooden or leather top · Plateau en bois ou cuir
Holz oder Leder Tischplatte · Plano de madera y piel

20	10	10	GZ.0160.01	175	1	0,01
----	----	----	-------------------	------------	---	------

Piano vetro · Glass top · Plateau en verre
Glas Tischplatte · Plano de vidrio

20	10	10	GZ.0160.V1	204	1	0,01
----	----	----	-------------------	------------	---	------

Vaschetta portacavi (con attacchi per piani legno)
Cables holder baskets (with attacks for wooden tops)
Bac porte-câble (avec fixations pour plateau en bois)
Kabelwanne (mit anschlüssen für Holz Tischplatte)
Cestos portaenchufes (con uniones para tapas de madera)

180/200/220

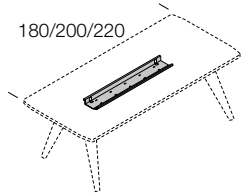

MZ.0090.01

240

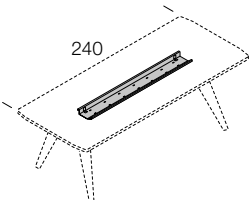

MZ.0110.01

Finitura · Finish · Finition
Ausführung · Acabado

NF

++++
weeks
2

89	19,6	5,9	MZ.0090.01	86	3	0,02
----	------	-----	-------------------	-----------	---	------

109	19,6	5,9	MZ.0110.01	92	3	0,02
-----	------	-----	-------------------	-----------	---	------

Scocca e podio · Structure and podium · Structure et podio
Korpus und Podium · Estructura y podio

BL	MK			L_		
BL	MK	RB	RC	L_	RB	RC
		RG	RK		RG	RK
		RR	RT		RR	RT
		RU			RU	

++++ weeks 4	++++ weeks 4	++++ weeks 4	++++ weeks 4
--------------------	--------------------	--------------------	--------------------

W D H Cod.
cm cm cm

Kg m³



2 coppie ante, 2 serrature
2 pair of doors, 2 locks
2 paires de portes, 2 serrures
2 Paar Türen, 2 Schlösser
2 dos puertas, 2 cerraduras

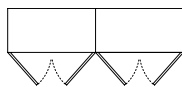
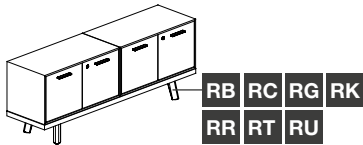

Aggiungere top RT.1604.00
Add top RT.1604.00
Ajouter le top RT.1604.00
Abdeckplatte RT.1604.00 Hinzufügen
Añadir parte superior RT.1604.00

160,3	40	62,5	RC.1606.A0	1.685	1.999	2.573	2.733	58	0,36
-------	----	------	------------	-------	-------	-------	-------	----	------

4 coppie ante e 4 serrature
4 pair of doors and 4 locks
4 paires de portes et 4 serrures
4 Paar Türen und 4 Schlösser
4 dos puertas y 4 cerraduras

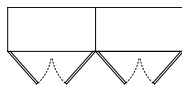
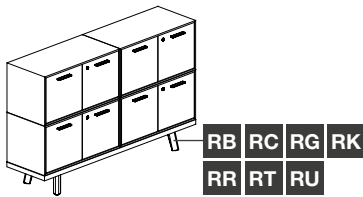

Aggiungere top RT.1604.00
Add top RT.1604.00
Ajouter le top RT.1604.00
Abdeckplatte RT.1604.00 Hinzufügen
Añadir parte superior RT.1604.00

160,3	40	102,5	RC.1610.A4	2.665	3.293	4.323	4.643	97	0,67
-------	----	-------	------------	-------	-------	-------	-------	----	------

2 coppie ante e 2 tramezze, 4 ripiani, 2 serrature
2 pair of doors and 2 partitions, 4 shelves, 2 locks
2 paires de portes et 2 cloisons, 4 étagères, 2 serrures
2 Paar Türen und 2 Zwischenseiten, 4 Einlegeböden, 2 Schlösser
2 dos puertas y 2 tabiques, 4 estantes, 2 cerraduras

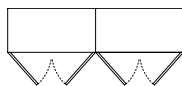
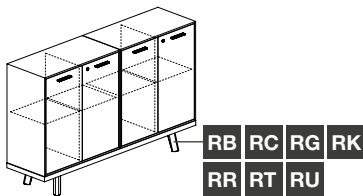

Aggiungere top RT.1604.00
Add top RT.1604.00
Ajouter le top RT.1604.00
Abdeckplatte RT.1604.00 Hinzufügen
Añadir parte superior RT.1604.00

160,3	40	102,5	RC.1610.A2	2.161	2.771	3.715	4.015	82	0,5
-------	----	-------	------------	-------	-------	-------	-------	----	-----

2 ante e 2 ripiani, 2 serrature, 4 vani a giorno
2 doors and 2 shelves, 2 locks, 4 open compartments
2 portes et 2 étagères, 2 serrures, 4 niches à jour
2 Türen und 2 Einlegeböden, 2 Schlösser, 4 offene Fächer
2 puertas y 2 estantes, 2 cerraduras, 4 elemento abierto

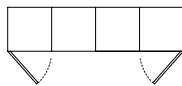
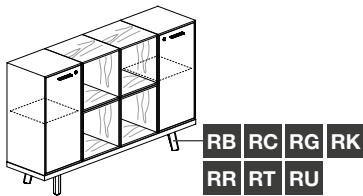

Aggiungere top RT.1604.00
Add top RT.1604.00
Ajouter le top RT.1604.00
Abdeckplatte RT.1604.00 Hinzufügen
Añadir parte superior RT.1604.00

160,3	40	102,5	RC.1610.G4	3.399	3.703	4.237	4.375	112	0,76
-------	----	-------	------------	-------	-------	-------	-------	-----	------

Top
Top
Top
Abdeckplatte
Parte superior

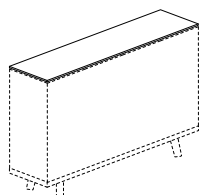

Finitura · Finish · Finition Ausführung · Acabado						
BL	MK			L_		
		RB	RC		RB	RC
		RG	RK		RG	RK
		RR	RT		RR	RT
		RU			RU	
++++ weeks 4	++++ weeks 4	++++ weeks 4				

160,6	40	1,2	RT.1604.00	88	252	323	5	0,03
-------	----	-----	------------	----	-----	-----	---	------

Scocca e podio · Structure and podium · Structure et podio
Korpus und Podium · Estructura y podio

BL MK

L_

Ante e frontali · Doors and frontals · Portes et façades
Türen und Fronten · Puertas y frontales

BL MK

RB RC

L_

RB RC

RG RK

RG RK

RR RT

RR RT

RU

RU

W D H
cm cm cm Cod.

Kg m³



weeks

4 weeks

4 weeks

4 weeks

4 weeks

2 coppie ante, 2 serrature, 1 vano a giorno
2 pair of doors, 2 locks, 1 open compartment
2 paires de portes, 2 serrures, 1 niche à jour
2 Paar Türen, 2 Schlösser, 1 offene Fächer
2 dos puertas, 2 cerraduras, 1 elemento abierto

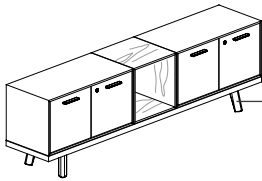

RB RC RG RK
RR RT RU

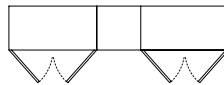

Aggiungere top RT.2004.00
Add top RT.2004.00
Ajouter le top RT.2004.00
Abdeckplatte RT.2004.00 Hinzufügen
Añadir parte superior RT.2004.00

200,6 40 62,5 RC.2006.G0

2.298

2.612

3.224

3.384

74 0,47

4 coppie ante, 4 serrature, 2 vani a giorno
4 pair of doors, 4 locks, 1 open compartments
4 paires de portes, 4 serrures, 4 niches à jour
4 Paar Türen, 4 Schlösser, 2 offene Fächer
4 dos puertas, 4 cerraduras, 2 elemento abierto

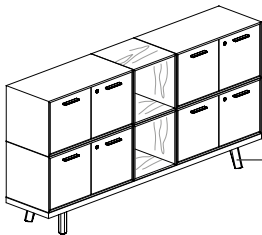

RB RC RG RK
RR RT RU

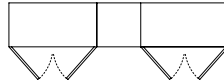

Aggiungere top RT.2004.00
Add top RT.2004.00
Ajouter le top RT.2004.00
Abdeckplatte RT.2004.00 Hinzufügen
Añadir parte superior RT.2004.00

200,6 40 102,5 RC.2010.AG

3.728

4.356

5.424

5.744

125 0,87

2 coppie ante e 2 tramezze, 1 anta dx, 5 ripiani, 3 serrature
2 pair of doors and 2 partitions, 1 rh door, 5 shelves, 3 locks
2 paires de portes et 2 cloisons, 1 porte dr, 5 étagères, 3 serrures
2 Paar Türen und 2 Zwischenseiten, 1 rechte Tür, 5 Einlegeböden, 3 Schlösser
2 dos puertas y 2 tabiques, 1 puerta derecha, 5 estantes, 3 cerraduras

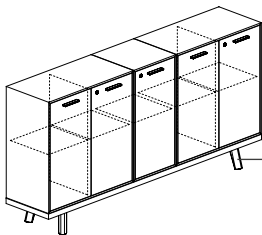

RB RC RG RK
RR RT RU

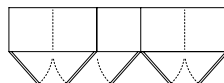

Aggiungere top RT.2004.00
Add top RT.2004.00
Ajouter le top RT.2004.00
Abdeckplatte RT.2004.00 Hinzufügen
Añadir parte superior RT.2004.00

200,6 40 102,5 RC.2010.A3

2.771

3.533

4.723

5.092

111 0,69

Scocca e podio · Structure and podium · Structure et podio
Korpus und Podium · Estructura y podio

BL MK

L_

Ante e frontali · Doors and frontals · Portes et façades
Türen und Fronten · Puertas y frontales

BL MK

RB RC

L_

RB RC

RG RK

RG RK

RR RT

RR RT

RU

RU

W D H
cm cm cm Cod.

Kg m³



2 coppie ante e 2 tramezze, 4 ripiani, 2 serrature, 2 vani a giorno
2 pair of doors and 2 partitions, 4 shelves, 2 locks, 2 open compartments
2 paires de portes et 2 cloisons, 4 étagères, 2 serrures, 2 niches à jour
2 Paar Türen und 2 Zwischenseiten, 4 Einlegeböden, 2 Schlösser, 2 offene Fächer
2 dos puertas y 2 tabiques, 4 estantes, 2 cerraduras, 2 elemento abierto

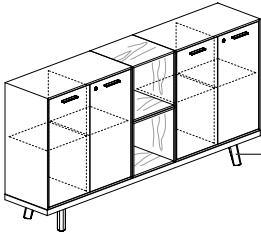

RB RC RG RK
RR RT RU

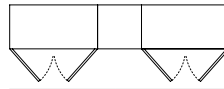

Aggiungere top RT.2004.00
Add top RT.2004.00
Ajouter le top RT.2004.00
Abdeckplatte RT.2004.00 Hinzufügen
Añadir parte superior RT.2004.00

200,6 40 102,5 RC.2010.C2 3.224 3.834 4.816 5.116 110 0,7

Top
Top
Top
Abdeckplatte
Parte superior

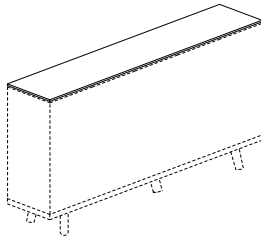

Finitura · Finish · Finition
Ausführung · Acabado

BL MK

L_

RB RC

RG RK

RR RT

RU

4 weeks

4 weeks

4 weeks

200,7 40 1,2 RT.2004.00 102 302 400 7 0,04

Scocca e podio · Structure and podium · Structure et podio
Korpus und Podium · Estructura y podio

BL	MK			L_			
Ante e frontali · Doors and frontals · Portes et façades Türen und Fronten · Puertas y frontales							
BL	MK	RB	RC	L_	RB	RC	
		RG	RK			RG	RK
		RR	RT			RR	RT
		RU			RU		

W D H
cm cm cm Cod.

Kg m³



++++ weeks 4	++++ weeks 4	++++ weeks 4	++++ weeks 4
--------------------	--------------------	--------------------	--------------------

2 coppie ante, 2 serrature, 2 vani a giorno
2 pair of doors, 2 locks, 2 open compartments
2 paires de portes, 2 serrures, 2 niches à jour
2 Paar Türen, 2 Schlösser, 2 offene Fächer
2 dos puertas, 2 cerraduras, 2 elemento abierto

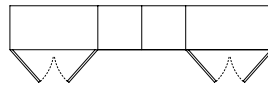
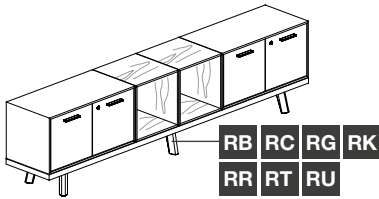

Aggiungere top RT.2404.00
Add top RT.2404.00
Ajouter le top RT.2404.00
Abdeckplatte RT.2404.00 Hinzufügen
Añadir parte superior RT.2404.00

240,9 40 62,5 RC.2406.G0 2.754 3.068 3.746 3.906 90 0,57

2 coppie ante, 2 cassetti, 3 serrature
2 pair of doors, 2 drawers, 3 locks
2 paires de portes, 2 tiroirs, 3 serrures
2 Paar Türen, 2 Schubläden, 3 Schlösser
2 dos puertas, 2 cajones, 3 cerraduras

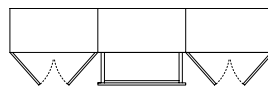
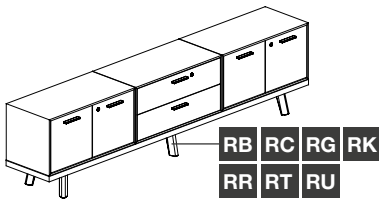

Aggiungere top RT.2404.00
Add top RT.2404.00
Ajouter le top RT.2404.00
Abdeckplatte RT.2404.00 Hinzufügen
Añadir parte superior RT.2404.00

240,9 40 62,5 RC.2406.B2 2.701 3.154 3.976 4.193 101 0,57

4 coppie ante e 4 serrature, 4 vani a giorno
4 pair of doors and 4 locks, 4 open compartments
4 paires de portes et 4 serrures, 4 niches à jour
4 Paar Türen und 4 Schlösser, 4 offene Fächer
4 dos puertas y 4 cerraduras, 4 elemento abierto

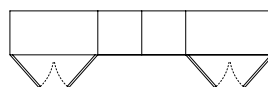
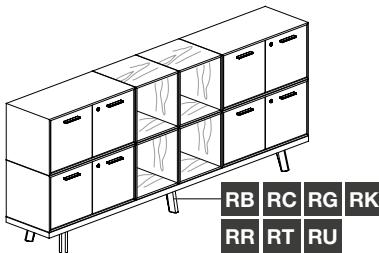

Aggiungere top RT.2404.00
Add top RT.2404.00
Ajouter le top RT.2404.00
Abdeckplatte RT.2404.00 Hinzufügen
Añadir parte superior RT.2404.00

240,9 40 102,5 RC.2410.AG 4.634 5.262 6.396 6.716 152 1,06

3 coppie ante, 3 tramezze, 6 ripiani, 3 serrature
3 pair of doors, 3 partitions, 6 shelves, 3 locks
3 paires de portes, 3 cloisons, 6 étagères, 3 serrures
3 Paar Türen, 3 Zwischenseiten, 6 Einlegeböden, 3 Schlösser
3 dos puertas, 3 tabiques, 6 estantes, 3 cerraduras

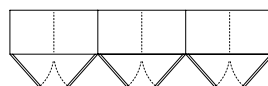
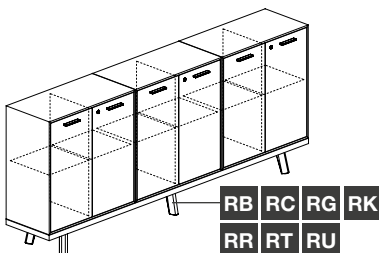

Aggiungere top RT.2404.00
Add top RT.2404.00
Ajouter le top RT.2404.00
Abdeckplatte RT.2404.00 Hinzufügen
Añadir parte superior RT.2404.00

240,9 40 102,5 RC.2410.A3 3.058 3.973 5.434 5.884 123 0,76

Scocca e podio · Structure and podium · Structure et podio
Korpus und Podium · Estructura y podio

BL	MK			L_			
Ante e frontali · Doors and frontals · Portes et façades Türen und Fronten · Puertas y frontales							
BL	MK	RB	RC	L_		RB	RC
		RG	RK			RG	RK
		RR	RT			RR	RT
		RU				RU	

W D H
cm cm cm Cod.

Kg m³



++++ weeks 4	++++ weeks 4	++++ weeks 4	++++ weeks 4
--------------------	--------------------	--------------------	--------------------

2 coppie ante, 2 tramezze, 4 ripiani, 2 serrature, 4 vani a giorno
2 pair of doors, 2 partitions, 4 shelves, 2 locks, 4 open compartments
2 paires de portes, 2 cloisons, 4 étagères, 2 serrures, 4 niches à jour
2 Paar Türen, 2 Zwischenseiten, 4 Einlegeböden, 2 Schlösser, 4 offene Fächer
2 dos puertas, 2 tabiques, 4 estantes, 2 cerraduras, 4 elemento abierto

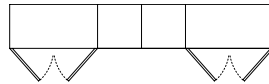
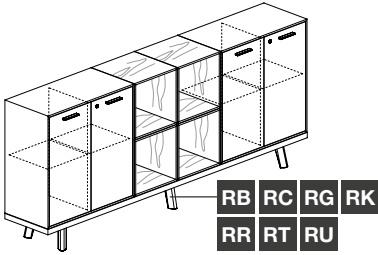

Aggiungere top RT.2404.00
Add top RT.2404.00
Ajouter le top RT.2404.00
Abdeckplatte RT.2404.00 Hinzufügen
Añadir parte superior RT.2404.00

240,9	40	102,5	RC.2410.C4	4.130	4.740	5.788	6.088	137	0,89
-------	----	-------	------------	-------	-------	-------	-------	-----	------

Top
Top
Top
Abdeckplatte
Parte superior

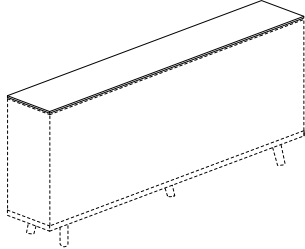

Finitura · Finish · Finition
Ausführung · Acabado

BL	MK			L_		RB	RC
						RG	RK
						RR	RT
						RU	

++++ weeks 4	++++ weeks 4	++++ weeks 4
--------------------	--------------------	--------------------

240,9	40	1,2	RT.2404.00	120	353	479	8	0,04
-------	----	-----	------------	-----	-----	-----	---	------

Scrivanie
 Desks
 Bureaux
 Schreibtische
 Escritorios

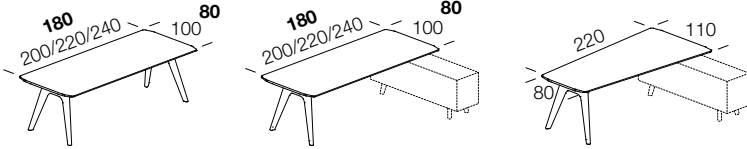

Tavoli
 Tables
 Tables
 Tische
 Mesas

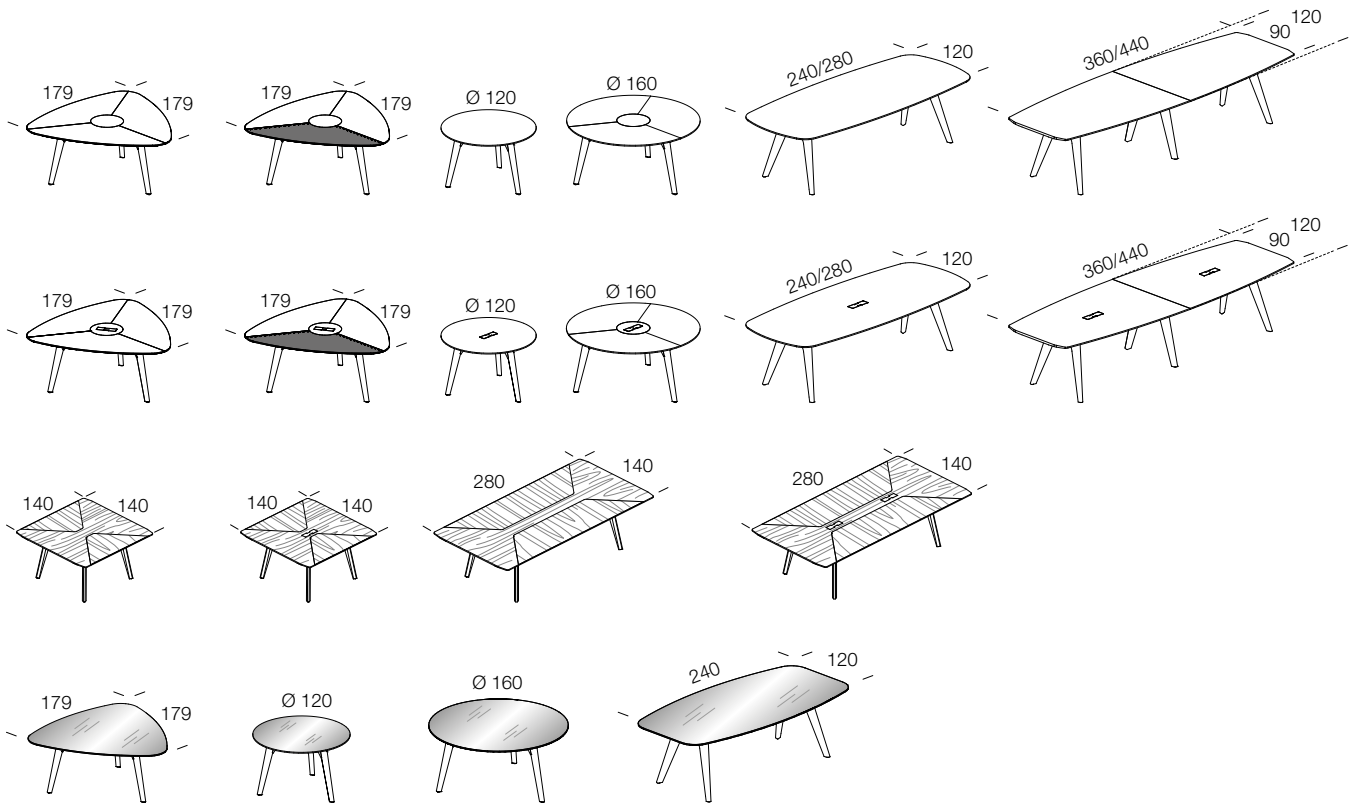

Tavolini da caffè
 Coffee tables
 Table basse
 Couchtisch
 Mesita para cortado

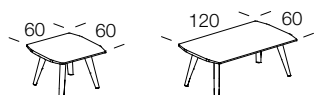

I cavi sono alloggiati in un'ampia vaschetta e possono essere bloccati con fascette che si inseriscono in apposite fessure.

The cables are collected in a wide tray and can be locked with clamps inserted in special slots.

Les câbles sont logés dans un grand bac et peuvent être bloqués avec des colliers qui s'insèrent dans des fentes prévues à cet effet.

Die Kabel sind in einem großen Behälter enthalten und können durch Klemmen, durch vorgesehene Schlitzze, blockiert werden.

Los cables están alojados en una amplia bandeja y pueden bloquearse con bridas, que se introducen en unas ranuras.

Lo spazio permette il passaggio dei cavi ad anta chiusa. La pressione esercitata dalle spazzole tiene in posizione i cavi.

The recess allows the passage of cables even with the door closed. The pressure exerted by the brushes maintains the cables in position.

L'espace permet le passage des câbles quand la porte est fermée. La pression exercée par les brosses maintient les câbles à leur emplacement.

Der ausreichende Raum ermöglicht die Kabeldurchführung bei geschlossener Tür. Der von den Bürsten ausgeübte Druck hält die Kabel in Position.

El espacio permite el paso de los cables con la puerta cerrada. La presión ejercida por los cepillos mantiene los cables en su posición.

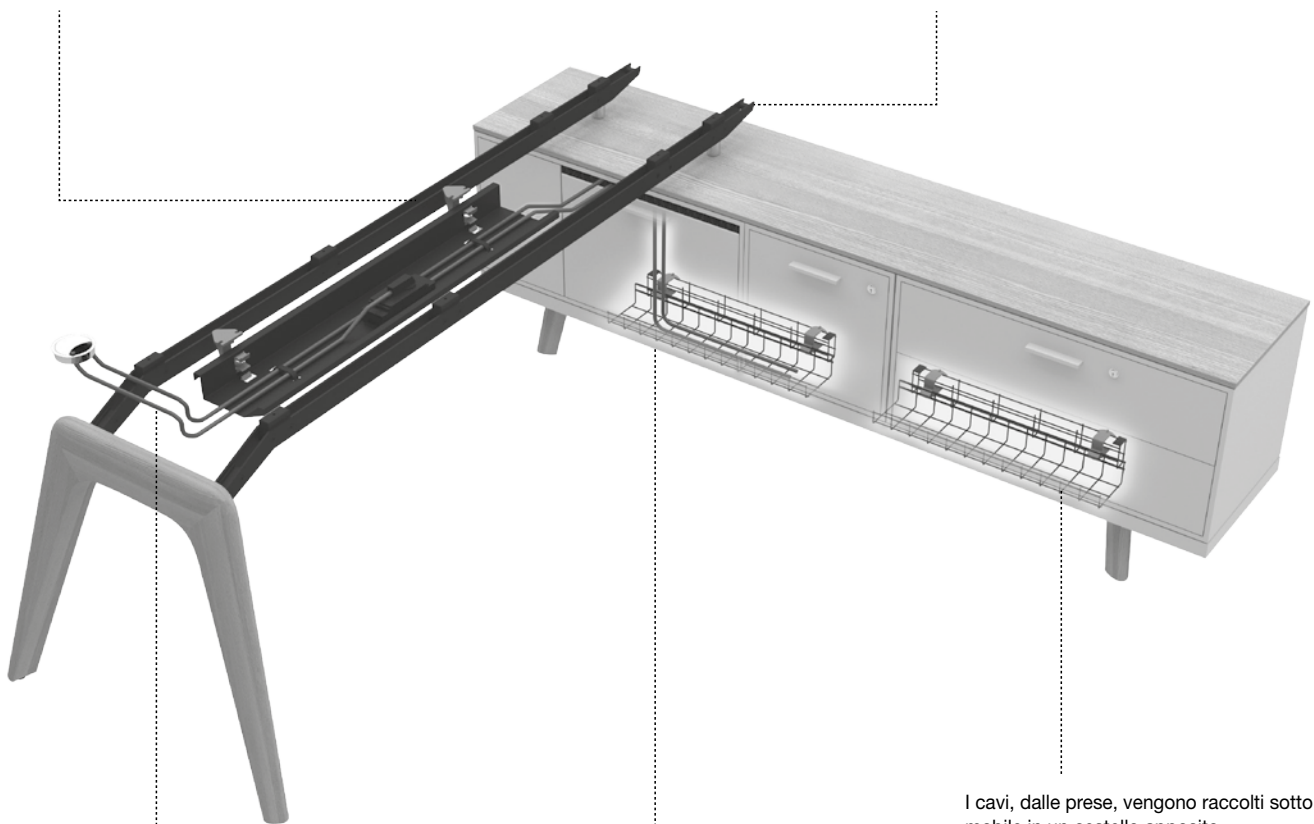

I cavi sono resi disponibili su piano attraverso appositi fori con sistema passacavi.

Cables are available on the top through cable grommet holes.

Les câbles arrivent sur le plateau à travers des trous avec un système passe-câbles.

Die Kabel stehen durch das Kabeldurchlasssystem auf der Tischplatte zur Verfügung.

Los cables resultan disponibles en el sobre gracias a unos orificios con sistema pasacables.

I cavi passano attraverso il mobile transitando da appositi passacavi.

Cables pass through the recesses within the piece of furniture.

Les câbles transitent dans des espaces situés à l'intérieur du meuble.

Die Kabel werden innerhalb des Schrankes geführt.

Los cables se extienden a lo largo de los espacios obtenidos en el interior del mueble.

I cavi, dalle prese, vengono raccolti sotto il mobile in un cestello apposito.

The cables are collected underneath the piece of furniture in a special tray.

À partir des prises, les câbles sont rassemblés sous le meuble dans un panier prévu pour cela.

Die Kabel werden von den Steckdosen unter dem Möbel in einem geeigneten Korb positioniert.

Los cables de las tomas de corriente se recogen debajo del mueble en una cesta.

Descrizioni tecniche

PIANI LEGNO MDF IMPIALLACCIATO:realizzati in mdf da 30 mm. di spessore, rivestiti in entrambi i lati con impiallacciatura di legno spess. 0,6mm e bordati perimetralmente con massello di legno spess. 1 mm. arrotondato con raggio 2 mm. I piani hanno il perimetro rastremato e smussato. La verniciatura è realizzata con tinta all'acqua e verniciatura finale acrilica trasparente oppure laccato con finitura a poro aperto. Il passaggio dei cavi è consentito da tappo passacavi cromato avente sezione 80 mm. alloggiato sul piano (optional). I piani dei tavoli da riunione possono essere sagomati per l'alloggiamento di scatole porta prese a scomparsa con sportello apribile longitudinalmente su entrambi i lati dotato di fessura per l'uscita cavi. Lo sportello è rifinito in legno con la stessa impiallacciatura e lo stesso colore del piano. Sono disponibili 2 dimensioni con piano intarsiato, realizzato tramite taglio di precisione ed incollaggio ad incastro dell'impiallacciatura con il senso della vena opposta.

TAVOLI RIUNIONE IN PELLE:realizzati in mdf da 28 mm. di spessore, rivestiti in entrambi i lati con pelle o pelle ecologica delicata e morbida al tatto. I piani hanno il perimetro rastremato e smussato. I piani in legno centrali possono essere sagomati per l'alloggiamento di scatole porta prese a scomparsa con sportello apribile longitudinalmente su entrambi i lati dotato di fessura per l'uscita cavi. Lo sportello è rifinito in legno con la stessa impiallacciatura e lo stesso colore del piano centrale.

TRAVI DI SOSTEGNO E COLLEGAMENTO PER SCRIVANIE E TAVOLI DA RIUNIONE LEGNO E PELLE:nella versione con piani in legno o pelle le travi sono costituite da 2 coppie di profili in lamiera d'acciaio avente 5 mm. di spessore sagomate al laser. Verniciatura a polvere epossidica colore nero opaco. Ogni coppia di esse è tenuta assieme da dei distanzianti metallici avvitati tra loro. Le travi sono agganciate alle staffe metalliche cromate già montate sulle gambe. Nel caso in cui le travi metalliche appoggino su l'elemento laterale, l'aggancio avverrà mediante cilindretti metallici cromati della sezione di 32x35 mm. di H.

PIANI SCRIVANIE E TAVOLI RIUNIONE-IN VETRO:realizzati in vetro temperato trasparente o fumé dello spessore di 12 mm. Perimetro a filo lucido smussato. I piani sono ancorati alle travi metalliche e cromate sottostanti mediante distanziali metallici di forma cilindrica da 32x35 mm h. Dotazione opzionale di passacavi cromato da 80 mm di diametro.

TRAVI DI SOSTEGNO E COLLEGAMENTO PER SCRIVANIE E TAVOLI DA RIUNIONE VETRO: Nella versione con piani in vetro sono costituite da 2 coppie di profili realizzati in lamiera d'acciaio avente 5 mm. di spessore sagomate al laser. Le travi sono cromate e collegate con distanziali in legno massello verniciato dello stesso colore della gamba, aventi la sezione di 43 x 35 mm. Nel caso in cui le travi metalliche appoggino su l'elemento laterale, l'aggancio avverrà mediante cilindretti metallici cromati della sezione di 32 x 35 mm. di H. Le travi sono agganciate alle staffe metalliche cromate di collegamento già montate sulle gambe.

GAMBE DELLE SCRIVANIE E DEI TAVOLI RIUNIONE:realizzate in massello di legno stondate, levigate e verniciate a poro aperto previa tinteggiatura ad acqua. Di forma a cavalletto e spessore 53 mm, presentano una dimensione di 800 x 690 mm h. Alla base è presente un piedino regolabile di 6 mm. Nei due alloggiamenti circolari interni della gamba, sono montate delle staffe metalliche cromate per il collegamento alle travi.

MODULI DI SERVIZIO E CREDENZE:realizzati con scocche montate in truciolare melaminico certificato E1, spessore 18mm. oppure con finitura laccato poliuretano vari colori a scelta. I frontali spessore 18 mm. possono essere in melaminico, laccati o rivestiti in entrambi i lati con impiallacciatura di legno spess. 6mm e bordati perimetralmente con massello di legno spess. 1 mm. arrotondato con raggio 2 mm. I moduli scocche di diverse dimensioni sono montati su podio in melaminico avente 38 mm. di spessore della stessa finitura delle scocche. Nei moduli di servizio sotto scrivania è consentito il transito ed il contenimento dei cavi elettrici ed informatici sotto al podio mediante l'utilizzo di cestelli passacavi ispezionabili. Il podio è sostenuto da piedi in legno massello h. 170 mm. Dotazione di piedino regolabile. Il top spessore 12 mm. ha come finiture il melaminico, il laccato poliuretano o impiallacciato legno.

MODESTY PANEL:sono realizzate in truciolare da 18 mm. impiallacciato come i piani della scrivania e sono fissate alle travi per mezzo di staffe di collegamento metalliche colore nero

Technical descriptions

MDF VENEERED TOPS:made of 30 mm thick MDF, faced on both sides with 0.6 mm thick wood veneer and edged with 1 mm rounded solid wood with 2 mm radius. The tops have a tapered and rounded edge. The painting is made with colored water and final transparent coat or lacquered open pore finish. The top is equipped with a 80 mm grommet cable hole (optional). The conference tabletops can be shaped to house recessed socket boxes with lid openable longitudinally in both directions equipped with cable hole. The door has the same finish veneer and the same colour as the top. The door is finished in wood veneer with the same color and the same surface. There are 2 sizes available with an veneer inlaid top, made by precision cutting and interlocking gluing of the veneer with the direction of the opposite vein.

LEATHER-UPHOLSTERED CONFERENCE TABLES:made of 28 mm thick MDF, faced on both sides with soft and delicate leather or eco-leather. The tops have a tapered and rounded edge. The central wood panels can be shaped to house recessed socket boxes with lid openable longitudinally in both directions equipped with cable hole. The door has the same finish veneer and the same colour as the central panel.

SUPPORTING AND CONNECTING PEDESTALS FOR DESKS AND LEATHER-WOOD CONFERENCE TABLES:In the version with wood or leather-upholstered tops, the pedestals comprise 2 pairs of 5 mm thick laser-cut steel sheet profile s. Coated with matt black epoxy powder. Each pair is fastened through metal spacers screwed to one another. The pedestals are fastened to the chrome-plated metal supports already installed on the legs. Where the metal pedestals rest on a side element, they're fastened through 32 x 35 mm h chrome-plated metal cylinders.

GLASS DESKTOPS AND CONFERENCE TABLES:made of 12 mm thick clear tempered glass or transparent smoke grey. Rounded flush clear edge. The tops are fastened to the chrome-plated metal pedestals underneath through 32 x 35 mm h cylinder metal spacers. Optional 80 mm diameter chrome-plated grommet cable hole.

SUPPORTING AND CONNECTING BEAMS FOR DESKS AND GLASS CONFERENCE TABLES: In the version with glass tops, the pedestals comprise 2 pairs of 5 mm thick laser-cut steel sheet profiles. The chrome-plated pedestals are connected with 43 x 35 mm solid wood spacers with the same colour as the leg. Where the metal pedestals rest on a side element, they're fastened through 32 x 35 mm h chrome-plated metal cylinders. The pedestals are fastened to the chrome-plated metal supports already installed on the legs.

LEGS FOR DESKS AND CONFERENCE TABLES:solid wood rounded and smooth legs, with waterbased coating and clear open-pore finishing. 53 mm thick, 800 x 690 mm h tripod legs. The base features a 6 mm adjustable foot. The two rounded slots within the leg feature chrome-plated metal supports to fasten the pedestals.

SERVICE CABINETS AND CUPBOARDS:shell made of 18 mm melamine veneer, E1 certification, or with polyurethane lacquered finishing, various colours. The 18 mm front panels can be made of melamine, lacquered or faced on both sides with 6 mm wood veneer and edged with 1 mm rounded solid wood with 2 mm radius. The shell modules with different sizes are installed on a 38 mm thick melamine base with the same finish as the shells. The service cabinets for installation underneath the desk feature cable trays to house electric and IT cables underneath the service cabinets' top. The top is supported by 170 mm h solid wood feet with the same finish as the desk legs. Equipped with 6 mm adjustable foot. The 12 mm top can be finished with melamine polyurethane lacquered wood or wood veneer. The 12 mm thick top has a white melamine, polyurethane lacquer or veneer finish.

MODESTY PANEL:made of 18 mm chipboard panel, veneered as the desktop, and fastened to the pedestals through black metal connection brackets.

legno · veneer · bois · holz · madera

R_



rovere laccato nero
black lacquered oak
chêne laqué noir
schwarz lackierter Eiche
roble lacado negro

RK



rovere Carbon
Carbon oak
chêne Carbon
Eiche Carbon
roble Carbon

RC

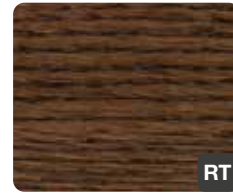

rovere tabacco
tobacco oak
chêne tabac
Eiche Tabak
roble tabacco

RT



rovere grigio scuro
dark grey oak
chêne gris foncé
dunkelgraue Eiche
roble gris oscuro

RU



rovere grigio
grey oak
chêne gris
Eiche grau
roble gris

RG



rovere naturale
natural oak
chêne naturel
Natur Eiche
roble natural

RR



rovere laccato bianco
white lacquered oak
chêne laqué blanc
weiß lackierter Eiche
roble lacado blanco

RB



rovere laccato titanio
titanium lacquered
oak chêne laqué titane
titan lackierter Eiche
roble lacado titanio

R4



rovere laccato tortora
turtledove lacquered oak
chêne laqué tourterelle
turteltaube lackierter
Eiche roble lacado tortora

R2

melaminico · melamine · mélamine · melamin · melamina

M



nero
black
noir
schwarz
negro

MK



grigio titanio
titanium grey
gris titane
titangrau
gris titanio

GS



grigio perla
pearl-grey
gris perle
perlgrau
gris perla

GP



tortora
turtledove
tourterelle
taubengrau
törtola

MO

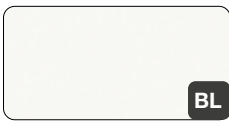

bianco
white
blanc
weiß
blanco

BL



noce Lux
walnut Lux
noyer Lux
lux Nussbaum
nogal Lux

NX



noce canaletto
canaletto walnut
noyer canaletto
Canaletto Nussbaum
nogal canaletto

NC



rovere naturale
natural oak
chêne naturel
Natur Eiche
roble natural

RN



rovere anticato
traditional oak
chêne vieilli
Eiche Antik
roble antiguo

RA



rosso rubino
ruby red
rouge rubis
rubinrot
rojo rub

RD



RD = Solo Domomag
Only Domomag · Seulement Domomag
Nur Domomag · Sólo Domomag



RA
Superficie antibatterica
Antibacterial surface
Surface antibactérienne
Antibakterielle Oberfläche
Superficie antibacteriana

bordo ABS · ABS edge · chant ABS · ABS-Kante · borde ABS

A



nero
black
noir
schwarz
negro

MK



grigio titanio
titanium grey
gris titane
titangrau
gris titanio

GS



grigio perla
pearl-grey
gris perle
perlgrau
gris perla

GP



tortora
turtledove
tourterelle
taubengrau
törtola

MO

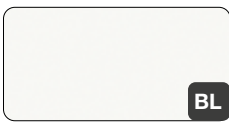

bianco
white
blanc
weiß
blanco

BL



noce Lux
walnut Lux
noyer Lux
lux Nussbaum
nogal Lux

NX



noce canaletto
canaletto walnut
noyer canaletto
Canaletto Nussbaum
nogal canaletto

NC



rovere naturale
natural oak
chêne naturel
Natur Eiche
roble natural

RN



rovere anticato
traditional oak
chêne vieilli
Eiche Antik
roble antiguo

RA



oliva
olive
olive
olive
oliva













L8



terracotta
terracotta
terre cuite
terrakotta
terracota

L10







strutture metalliche · metal structures · structures métalliques · metallgestelle · estructuras metálicas

 NF	nero black noir schwarz negro	 FG	ferro grezzo raw steel métal brut rohes Metall hierro bruto	 GF	grigio titanio titanium grey gris titane titangrau gris titanio
 TF	tortora turtledove tourterelle taubengrau törtola	 AF	epox alluminio silver epoxy epoxy aluminium epoxy aluminium epoxidico aluminio	 BW	bianco white blanc weiß blanco
 VF	oliva olive olive olive oliva	 CF	terracotta terracotta terre cuite terracotta terracota	 KR	cromo lucido glossy chrome chromé brillant Chrom poliert cromo brillo
 BR	brunito (solo Arche) burnished (only Arche) bruni (seulement Arche) brüniert (nur Arche) bruñido (sólo Arche)	 EF	grigio ombra shadow grey gris ombre vulcanschwarz sombra gris	 PF	rame rosa pink copper cuivre rose kupfer-Pink cobre rosa

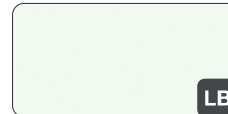





 seating hub NF = alluminio verniciato nero, black painted aluminium aluminium, peint noir aluminium, schwarz lackiert, aluminio pintado negro KR = acciaio cromato (All), chromed steel (All), acier chromé (All), verchromter Stahl (All), acero cromado (All)

FG: La finitura ferro grezzo "FG" risalta la natura "industriale" del metallo grazie ad un trattamento protettivo trasparente. Differenze di tonalità, abrasioni, striature e saldature sono tipici della materia prima stessa e delle successive lavorazioni e sono tra gli elementi caratterizzanti del prodotto e per questo non contestabili.
FG: The raw steel finish "FG" emphasizes the "industrial" nature of the metal thanks to a transparent protective treatment. Differences in shades, abrasions, stripes and welds are typical of the raw material and subsequent processes, and are among the characteristic elements of the product, therefore not claimable.
FG: La finition en métal brut "FG" démarque la nature "industrielle" du Métal grâce à un traitement avec une protection transparent. Les différences dans les nuances, les abrasions et les soudures sont typiques de la matière première et des ultérieures process de production et font partie des éléments caractéristiques du produit et donc non contestables.
FG: Das rohes Metall-Finish "FG" sticht besonders hervor der "Industriellen" Natur der Metall durch einer Transparenten Schutz Behandlung. Unterschiede in Farbton, Abrieb, Streifen und Schweissungen sind typisch für den Rohstoff und die nachfolgenden Prozesse und gehören zu den charakteristischen Elementen des Produkts und daher sind nicht anfechtbar.
FG: El acabado de hierro bruto "FG" destaca la naturaleza "industrial" del Metal gracias a un tratamiento protector transparente. Las diferencias en los tonos, abrasiones, rayas y soldaduras son típicas de la materia prima y los procesos posteriores y se encuentran entre los elementos característicos del producto y, por lo tanto, es indiscutible.

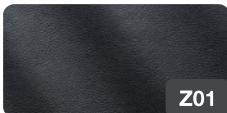
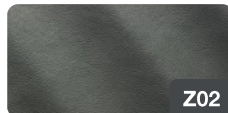
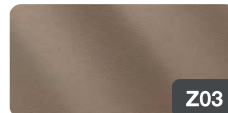
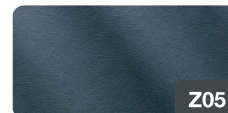

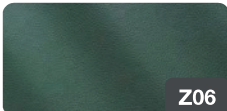

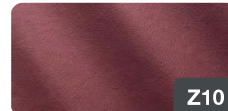

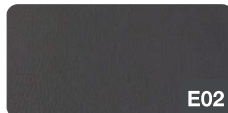

laccato opaco · lacquered matt · lacqué mat · matt lackiert · lacado mate

L	 LN	 L4	 L2	 LB
	 L7	 L5	 L8	 L9
	 L10	 L11	 L12	 LJ

pelle · leather · cuir · Leder · piel

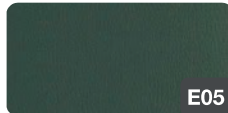
PL1	 Z01	 Z02	 Z03	 Z05	 Z13
	 Z06	 Z14	 Z10	 Z11	 Z12

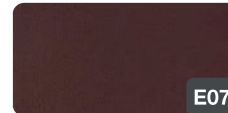
pelle ecologica · eco-leather · peau écologique · Kunstleder · eco-piel

PE1	 E01	 E02	 E10	 E03	 E04
	 E11	 E05	 E12	 E07	 E08
	 E09				

acrilico lucido · glossy acrylic · acrylique brillant · glänzende acryl · acrílico brillo



nero
black
noir
schwarz
negro



bianco
white
blanc
weiß
blanco

vetro stampato · printed glass · verre imprimé · Bedrucktes Glas · vidrio impreso

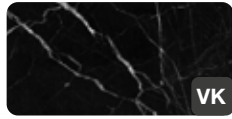

nero marquinia
black marquinia
noir marquinia
schwarz marquinia
marquinia negro



bianco calacatta
white calacatta
blanc calacatta
weiß calacatta
calacatta blanco

vetro temperato retrolaccato · back-lacquered tempered glass · verre retro-lacqué trempé · sicherheitsglas rückseitig lackier · vidrio retrolacado templado **C_** (lucido · glossy · brillant · poliert · brillo) **S_** (opaco · matt · opaque · matt · mate)



nero
black
noir
schwarz
negro



titanio
titanium
titane
titan
titanio



tortora
turtledove
tourterelle
taubengrau
tortola



bianco
white
blanc
weiß
blanco

vetro temperato · tempered glass · verre trempé · sicherheitsglas · vidrio templado



fumé
transparent smoke grey
gris fumé
Rauchglas
gris ahumado



satinato
frosted
satiné
geätztem Glas
satinado



trasparente
transparent
Klarsicht Glas
transparente

plastica · plastic · plastique · Plastik · plástico



nero
black
noir
schwarz
negro

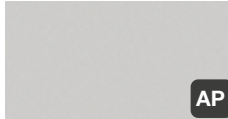

alluminio
aluminium
aluminium
aluminium
aluminio



bianco
white
blanc
weiß
blanco



cromo lucido
glossy chrome
chromé brillant
Chrom poliert
cromo brillo



trasparente
transparent
transparent
klarsicht
transparente

tecnopolimero · technopolymer · technopolymère · technopolymer · tecnopolimero

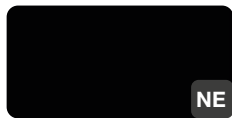

nero
black
noir
schwarz
negro



bianco
white
blanc
weiß
blanco



alluminio spazzolato lucido
polished brushed aluminum
aluminium brossé poli
aluminium poliert
aluminio brillo pulido



P1P



P2P



P6P



P4P



P5P

metacrilato · methacrylate · méthacrylate · Methacrylat · metacrilato



nero opaco
black matt
noir mat
schwarz matt
negro mate



grigio opaco
grey matt
gris mat
grau matt
gris mate



bianco opaco
white matt
blanc mat
weiß matt
blanco mate