

Jet

Scrivanie · Desks · Bureaux
Schreibtische · Escritorios

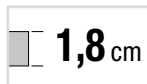

Gambe e piano · Legs and worktop · Piètements et plateau
Beine und tischplatte · Patas y plano

NC RN

W D H
cm cm cm Cod.

Kg m³



3 weeks

Scrivania con gambe a colonna
Desk with column legs
Bureau avec piètements colonne
Schreibtisch mit Säule
Escritorio con patas de columna

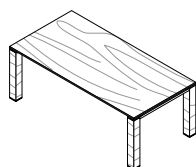

W	D	H	Cod.	Price	Weight	Volume
80	60	74	DS.0806.00	1.061	33	0,17
100	60	74	DS.1006.00	1.069	35	0,17
120	60	74	DS.1206.00	1.110	39	0,18
180	60	74	DS.1806.00	1.135	44	0,18
200	60	74	DS.2006.00	1.167	49	0,19
160	80	74	DS.1608.00	1.162	48	0,26
180	80	74	DS.1808.00	1.173	50	0,27
200	80	74	DS.2008.00	1.212	56	0,28
180	100	74	DS.1810.00	1.238	56	0,49
200	100	74	DS.2010.00	1.278	62	0,5

Scrivania con gamba a colonna ridotta
Desk with reduced leg
Bureau avec pied colonne réduit
Schreibtisch mit verkürztem Säule
Escritorio con pata redujo

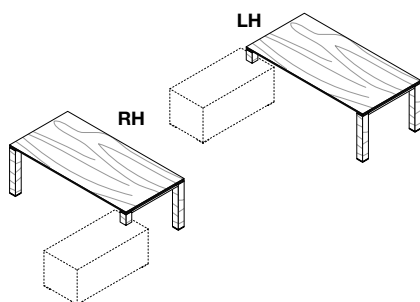

W	D	H	Cod.	Price	Weight	Volume
RH 160	80	74	DS.1608.DZ	1.144	46	0,25
RH 180	80	74	DS.1808.DZ	1.155	48	0,26
RH 200	80	74	DS.2008.DZ	1.194	54	0,27
RH 180	100	74	DS.1810.DZ	1.219	54	0,4
RH 200	100	74	DS.2010.DZ	1.259	60	0,41
LH 160	80	74	DS.1608.SZ	1.144	46	0,25
LH 180	80	74	DS.1808.SZ	1.155	48	0,26
LH 200	80	74	DS.2008.SZ	1.194	54	0,27
LH 180	100	74	DS.1810.SZ	1.219	54	0,4
LH 200	100	74	DS.2010.SZ	1.259	60	0,41

Scrivania a ponte con gambe a colonna ridotte
Bridge desk with reduced columns leg
Bureau avec pied colonne réduit
Schreibtisch mit verkürztem Säule
Escritorio con pata redujo

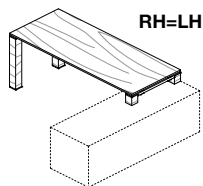

W	D	H	Cod.	Price	Weight	Volume
160	80	74	DS.1608.01	1.032	39	0,19
180	80	74	DS.1808.01	1.043	41	0,2
200	80	74	DS.2008.01	1.082	47	0,21
180	100	74	DS.1810.01	1.103	47	0,32
200	100	74	DS.2010.01	1.143	53	0,34

Dattilo agganciato con gambe a colonna
Hanging return with column legs
Retour suspendu avec piètement colonne
Ansatz Tisch mit säule
Plano retraible enganchado con patas de columna

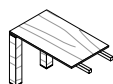

W	D	H	Cod.	Price	Weight	Volume
80	60	74	DS.0806.B0	680	23	0,1
100	60	74	DS.1006.B0	720	28	0,1
120	60	74	DS.1206.B0	729	29	0,11

Piano conversazione con gambe a colonna
Front brief desk with column leg
Plan de conversation avec piètement colonne
Besprechungsplatte auf Säule
Plano de conversación con patas de columna

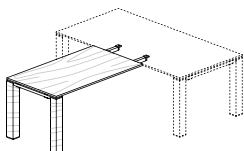

W	D	H	Cod.	Price	Weight	Volume
140	80	74	DS.1408.B0	759	35	0,16

Jet

Scrivanie · Desks · Bureaux
Schreibtische · Escritorios

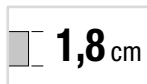

Gambe e piano · Legs and worktop · Piètements et plateau
Beine und tischplatte · Patas y plano

NC RN

W D H
cm cm cm Cod.

Kg m³



3 weeks

Scrivania con gambe a pannello
Desk with panelled legs
Bureau avec piètements panneaux
Schreibtisch mit Wangengestell
Escritorio con patas de panel

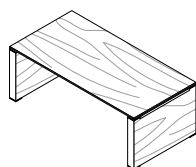

W	D	H	Cod.	Price	Kg	m ³
80	60	74	DS.0806.A0	1.299	45	0,17
100	60	74	DS.1006.A0	1.307	47	0,17
120	60	74	DS.1206.A0	1.348	52	0,18
180	60	74	DS.1806.A0	1.373	56	0,18
200	60	74	DS.2006.A0	1.405	61	0,19
160	80	74	DS.1608.A0	1.448	59	0,23
180	80	74	DS.1808.A0	1.459	61	0,24
200	80	74	DS.2008.A0	1.498	66	0,25
180	100	74	DS.1810.A0	1.574	81	0,49
200	100	74	DS.2010.A0	1.614	87	0,5

Scrivania a ponte con gambe a colonna ridotte
Bridge desk with reduced columns leg
Bureau avec pied colonne réduit
Schreibtisch mit verkürztem Säule
Escritorio en puente con pata de columna redujo

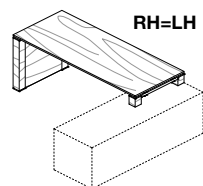

W	D	H	Cod.	Price	Kg	m ³
160	80	74	DS.1608.A1	1.175	45	0,18
180	80	74	DS.1808.A1	1.186	47	0,18
200	80	74	DS.2008.A1	1.225	52	0,19
180	100	74	DS.1810.A1	1.271	60	0,32
200	100	74	DS.2010.A1	1.311	66	0,34

Dattilo agganciato con gambe a pannello
Hanging return with panelled legs
Retour suspendu avec piètement panneaux
Ansatztisch mit wangen
Piano retraibile enganchado con patas de panel

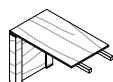

W	D	H	Cod.	Price	Kg	m ³
80	60	74	DS.0806.C0	799	29	0,1
100	60	74	DS.1006.C0	839	34	0,1
120	60	74	DS.1206.C0	848	36	0,11

Piano conversazione con gambe a pannello
Front brief desk with panelled leg
Plan de conversation avec pieds panneaux
Besprechungsplatte auf wangen
Plano de conversación con patas de panel

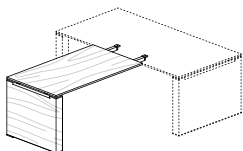

W	D	H	Cod.	Price	Kg	m ³
140	80	74	DS.1408.C0	902	41	0,15

Jet

Scrivanie · Desks · Bureaux
Schreibtische · Escritorios

3,8 cm

Gambe e piano · Legs and worktop · Piètements et plateau
Beine und tischplatte · Patas y plano

NC RN

W D H
cm cm cm Cod.

Kg m³



weeks

3

Scrivania con gambe a colonna
Desk with column legs
Bureau avec piètements colonne
Schreibtisch mit Säule
Escritorio con patas de columna

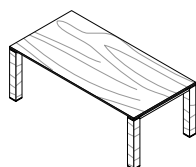

W	D	H	Cod.			
80	60	76	DD.0806.04	1.139		40 0,19
100	60	76	DD.1006.04	1.175		43 0,2
120	60	76	DD.1206.04	1.239		49 0,21
180	60	76	DD.1806.04	1.336		59 0,24
200	60	76	DD.2006.04	1.401		65 0,25
160	80	76	DD.1608.04	1.413		66 0,29
180	80	76	DD.1808.04	1.464		70 0,3
200	80	76	DD.2008.04	1.527		78 0,32
180	100	76	DD.1810.04	1.580		81 0,53
200	100	76	DD.2010.04	1.652		90 0,54

Scrivania con gamba a colonna ridotta
Desk with reduced leg
Bureau avec pied colonne réduit
Schreibtisch mit verkürzter Säule
Escritorio con pata redujo

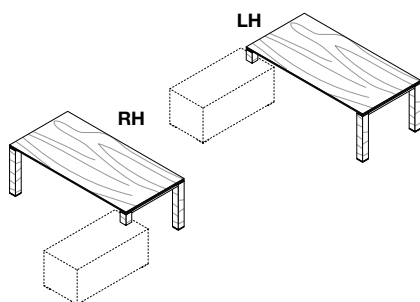

	W	D	H	Cod.		
RH	160	80	76	DD.1608.DZ	1.395	64 0,28
RH	180	80	76	DD.1808.DZ	1.446	68 0,29
RH	200	80	76	DD.2008.DZ	1.509	75 0,31
RH	180	100	76	DD.1810.DZ	1.561	79 0,43
RH	200	100	76	DD.2010.DZ	1.633	87 0,45
LH	160	80	76	DD.1608.SZ	1.395	64 0,28
LH	180	80	76	DD.1808.SZ	1.446	68 0,29
LH	200	80	76	DD.2008.SZ	1.509	75 0,31
LH	180	100	76	DD.1810.SZ	1.561	79 0,43
LH	200	100	76	DD.2010.SZ	1.633	87 0,45

Scrivania a ponte con gambe a colonna ridotte
Bridge desk with reduced columns leg
Bureau avec pied colonne réduit
Schreibtisch mit verkürzter Säule
Escritorio en puente con pata de columna redujo

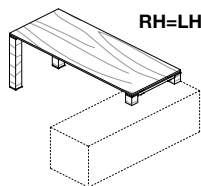

	W	D	H	Cod.		
	160	80	76	DD.1608.01	1.283	57 0,22
	180	80	76	DD.1808.01	1.334	61 0,23
	200	80	76	DD.2008.01	1.397	69 0,25
	180	100	76	DD.1810.01	1.445	72 0,36
	200	100	76	DD.2010.01	1.517	81 0,38

Dattilo agganciato con gambe a colonna
Hanging return with column legs
Retour suspendu avec piètement colonne
Ansatz Tisch mit säule
Piano retraible enganchado con patas de columna

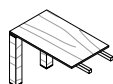

	W	D	H	Cod.		
	80	60	76	DD.0806.B4	758	30 0,12
	100	60	76	DD.1006.B4	826	36 0,13
	120	60	76	DD.1206.B4	858	39 0,14

Piano conversazione con gambe a colonna
Front brief desk with column leg
Plan de conversation avec piètement colonne
Besprechungsplatte auf Säule
Plano de conversación con patas de columna

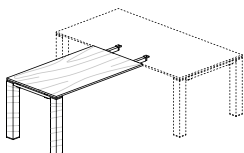

	W	D	H	Cod.		
	140	80	76	DD.1408.B4	974	51 0,19

Jet

Scrivanie · Desks · Bureaux
Schreibtische · Escritorios

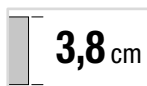

Gambe e piano · Legs and worktop · Piètements et plateau
Beine und tischplatte · Patas y plano

NC RN

W D H
cm cm cm Cod.

Kg m³



3 weeks

Scrivania con gambe a pannello
Desk with panelled legs
Bureau avec piètements panneaux
Schreibtisch mit Wangengestell
Escritorio con patas de panel

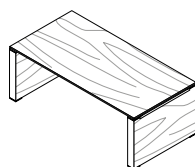

W	D	H	Cod.	Price	Kg	m ³
80	60	76	DD.0806.A4	1.377	52	0,19
100	60	76	DD.1006.A4	1.413	55	0,2
120	60	76	DD.1206.A4	1.477	62	0,21
180	60	76	DD.1806.A4	1.574	71	0,24
200	60	76	DD.2006.A4	1.639	78	0,25
160	80	76	DD.1608.A4	1.699	77	0,26
180	80	76	DD.1808.A4	1.750	81	0,27
200	80	76	DD.2008.A4	1.813	88	0,28
180	100	76	DD.1810.A4	1.916	106	0,53
200	100	76	DD.2010.A4	1.988	115	0,54

Scrivania a ponte con gambe a colonna ridotte
Bridge desk with reduced columns leg
Bureau avec pied colonne réduit
Schreibtisch mit verkürztem Säule
Escritorio en puente con pata de columna redujo

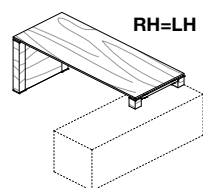

W	D	H	Cod.	Price	Kg	m ³
160	80	76	DD.1608.A1	1.426	62	0,2
180	80	76	DD.1808.A1	1.477	66	0,21
200	80	76	DD.2008.A1	1.540	74	0,23
180	100	76	DD.1810.A1	1.613	85	0,36
200	100	76	DD.2010.A1	1.685	93	0,38

Dattilo agganciato con gambe a pannello
Hanging return with panelled legs
Retour suspendu avec piètement panneaux
Ansattisch mit wangen
Piano retraibile enganchado con patas de panel

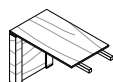

W	D	H	Cod.	Price	Kg	m ³
80	60	76	DD.0806.C4	877	36	0,12
100	60	76	DD.1006.C4	945	42	0,13
120	60	76	DD.1206.C4	977	45	0,14

Piano conversazione con gambe a pannello
Front brief desk with panelled leg
Plan de conversation avec pieds panneaux
Besprechungsplatte auf wangen
Plano de conversación con patas de panel

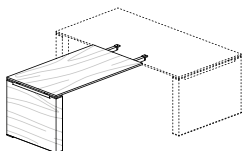

W	D	H	Cod.	Price	Kg	m ³
140	80	76	DD.1408.C4	1.117	56	0,17

Jet

Scrivanie · Desks · Bureaux
Schreibtische · Escritorios

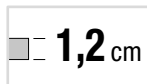

Gambe · Legs · Piètements Beine · Patas	
NC	RN
Piano · Worktop · Plateau Tischplatte · Plano	
C	S

W cm D cm H cm Cod.



Scrivania con gambe a colonna
Desk with column legs
Bureau avec piétements colonne
Schreibtisch mit Säule
Escritorio con patas de columna

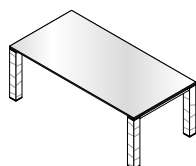

W	D	H	Cod.	1	2	Kg	m³
100	60	74	DS.1006.00	1.516	1.612	50	0,22
120	60	74	DS.1206.00	1.606	1.714	58	0,24
180	60	74	DS.1806.00	1.779	1.922	72	0,27
200	60	74	DS.2006.00	1.862	2.016	80	0,29
160	80	74	DS.1608.00	2.051	2.241	82	0,33
180	80	74	DS.1808.00	2.118	2.322	88	0,34
200	80	74	DS.2008.00	2.210	2.426	97	0,36
180	100	74	DS.1810.00	2.438	2.700	103	0,57
200	100	74	DS.2010.00	2.538	2.816	114	0,59

Scrivania con gamba a colonna ridotta
Desk with reduced leg
Bureau avec pied colonne réduit
Schreibtisch mit verkürztem Säule
Escritorio con pata redujo

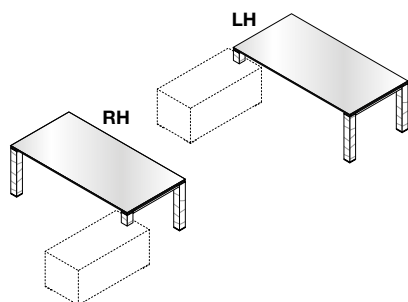

RH	160	80	74	DS.1608.DZ	2.033	2.223	79	0,32
RH	180	80	74	DS.1808.DZ	2.100	2.304	85	0,33
RH	200	80	74	DS.2008.DZ	2.192	2.408	95	0,35
RH	180	100	74	DS.1810.DZ	2.419	2.681	101	0,48
RH	200	100	74	DS.2010.DZ	2.519	2.797	112	0,5
LH	160	80	74	DS.1608.SZ	2.033	2.223	79	0,32
LH	180	80	74	DS.1808.SZ	2.100	2.304	85	0,33
LH	200	80	74	DS.2008.SZ	2.192	2.408	95	0,35
LH	180	100	74	DS.1810.SZ	2.419	2.681	101	0,48
LH	200	100	74	DS.2010.SZ	2.519	2.797	112	0,5

Scrivania a ponte con gambe a colonna ridotte
Bridge desk with reduced columns leg
Bureau avec pied colonne réduit
Schreibtisch mit verkürztem Säule
Escritorio en puente con pata de columna redujo

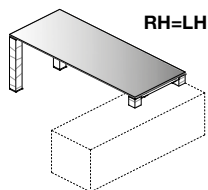

	160	80	74	DS.1608.01	1.921	2.111	73	0,26
	180	80	74	DS.1808.01	1.988	2.192	79	0,27
	200	80	74	DS.2008.01	2.080	2.296	88	0,29
	180	100	74	DS.1810.01	2.303	2.565	94	0,41
	200	100	74	DS.2010.01	2.403	2.681	105	0,43

Dattilo agganciato con gambe a colonna
Hanging return with column legs
Retour suspendu avec piétement colonne
Ansatz Tisch mit Säule
Plano retraible enganchado con patas de columna

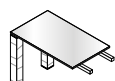

	100	60	74	DS.1006.B0	1.167	1.263	44	0,15
	120	60	74	DS.1206.B0	1.225	1.333	48	0,16

Piano conversazione con gambe a colonna
Front brief desk with column leg
Plan de conversation avec piétement colonne
Besprechungsplatte auf Säule
Plano de conversación con patas de columna

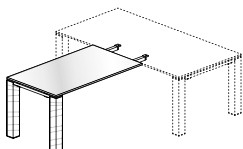

	140	80	74	DS.1408.B0	1.587	1.766	65	0,22
--	-----	----	----	------------	-------	-------	----	------

Jet

Scrivanie · Desks · Bureaux
Schreibtische · Escritorios

1,2 cm

Gambe · Legs · Piètements Beine · Patas	
NC	RN
Piano · Worktop · Plateau Tischplatte · Plano	
C	S

W cm D cm H cm Cod.

Kg m³



weeks

4

4

Scrivania con gambe a pannello
Desk with panelled legs
Bureau avec piètements panneaux
Schreibtisch mit Wangengestell
Escritorio con patas de panel

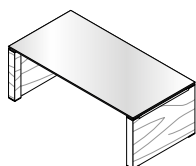

W	D	H	Cod.	1.754	1.850		
100	60	74	DS.1006.A0	1.754	1.850	63	0,22
120	60	74	DS.1206.A0	1.844	1.952	70	0,24
180	60	74	DS.1806.A0	2.017	2.160	84	0,27
200	60	74	DS.2006.A0	2.100	2.254	92	0,29
160	80	74	DS.1608.A0	2.337	2.527	92	0,29
180	80	74	DS.1808.A0	2.404	2.608	98	0,31
200	80	74	DS.2008.A0	2.496	2.712	108	0,33
180	100	74	DS.1810.A0	2.774	3.036	128	0,57
200	100	74	DS.2010.A0	2.874	3.152	139	0,59

Scrivania a ponte con gambe a colonna ridotte
Bridge desk with reduced columns leg
Bureau avec pied colonne réduit
Schreibtisch mit verkürztem Säule
Escritorio en puente con pata de columna redujo

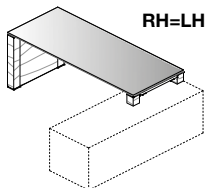

W	D	H	Cod.	2.064	2.254		
160	80	74	DS.1608.A1	2.064	2.254	78	0,24
180	80	74	DS.1808.A1	2.131	2.335	84	0,25
200	80	74	DS.2008.A1	2.223	2.439	94	0,27
180	100	74	DS.1810.A1	2.471	2.733	107	0,41
200	100	74	DS.2010.A1	2.571	2.849	118	0,43

Dattilo agganciato con gambe a pannello
Hanging return with panelled legs
Retour suspendu avec piètement panneaux
Ansatz Tisch mit Wangen
Piano retraible enganchado con patas de panel

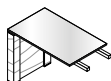

W	D	H	Cod.	1.286	1.382		
100	60	74	DS.1006.C0	1.286	1.382	50	0,15
120	60	74	DS.1206.C0	1.344	1.452	54	0,16

Piano conversazione con gambe a pannello
Front brief desk with panelled leg
Plan de conversation avec pieds panneaux
Besprechungsplatte auf Wangen
Plano de conversación con patas de panel

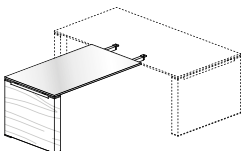

W	D	H	Cod.	1.730	1.909		
140	80	74	DS.1408.C0	1.730	1.909	70	0,2

NE



Tappo passacavi
Cable access port · Passe-cable carré
Kabeldurchlass · Tapon pasacables

Top, fianchi, schiene, ante · Top, sides, back, doors · Top, côtés, dos, portes
Abdeckplatte, Seitenteile, Rückwand, Türen · Top, costados, respaldo, puertas

NC RN

W D H
cm cm cm Cod.

Kg m³



3 weeks

2 ante, 4 cassetti, 3 serrature e vano frontale con anta
2 doors, 4 drawers, 3 locks and frontal compartment
2 portes, 4 tiroirs, 3 serrures et logement frontal avec porte
2 Türen, 4 Schubladen, 3 Schlösser und Frontfach mit Tür
2 puertas, 4 cajones, 3 cerraduras y compartimento frontal

LH

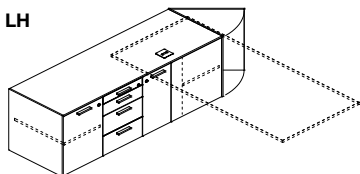

RH	167,8	56,2	54	EL.1705.4R	1.578	96	0,62
LH	167,8	56,2	54	EL.1705.4L	1.578	94	0,62

2 ante, 2 cassetti e 1 classificatore, 3 serrature e vano frontale con anta
2 doors, 2 drawers and 1 filing unit, 3 locks and frontal compartment
2 portes, 2 tiroirs, 1 classeur, 3 serrures et logement frontal avec porte
2 Türen, 2 Schubladen und 1 Hängeregistraturfach, 3 Schlösser und Frontfach mit Tür
2 puertas, 2 cajones y 1 clasificador, 3 cerraduras y compartimento frontal

LH

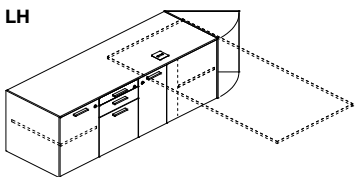

RH	167,8	56,2	54	EL.1705.3R	1.571	94	0,61
LH	167,8	56,2	54	EL.1705.3L	1.571	94	0,61

3 ante, 4 cassetti, 3 serrature e vano frontale con anta
3 doors, 4 drawers, 3 locks and frontal compartment
3 portes, 4 tiroirs, 3 serrures et logement frontal avec porte
3 Türen, 4 Schubladen, 3 Schlösser und Frontfach mit Tür
3 puertas, 4 cajones, 3 cerraduras y compartimento frontal

LH

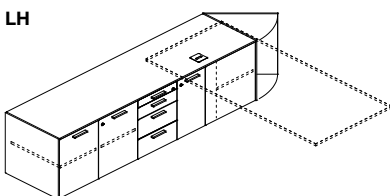

RH	209,5	56,2	54	EL.2105.4R	1.848	126	0,79
LH	209,5	56,2	54	EL.2105.4L	1.848	126	0,79

3 ante, 2 cassetti e 1 classificatore, 3 serrature e vano frontale con anta
3 doors, 2 drawers and 1 filing unit, 3 locks and frontal compartment
3 portes, 2 tiroirs, 1 classeur, 3 serrures et logement frontal avec porte
3 Türen, 2 Schubladen und 1 Hängeregistraturfach, 3 Schlösser und Frontfach mit Tür
3 puertas, 2 cajones y 1 clasificador 3 cerraduras y compartimento frontal

LH

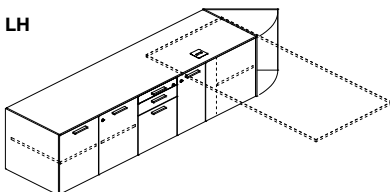

RH	209,5	56,2	54	EL.2105.3R	1.841	116	0,78
LH	209,5	56,2	54	EL.2105.3L	1.841	116	0,78

Jet

Accessori · Accessories · Accessoires
Zubehör · Accesorios

Staffe · Brackets · Étriers
Bügel · Estribos

AF BW NF

Gonna · Modesty panel · Voile de fond
Knieraumblende · Faldón

NC RN

W D H
cm cm cm Cod.

Kg m³



3 weeks

Modesty panel
Modesty panel
Voile de fond
Knieraumblende
Faldón

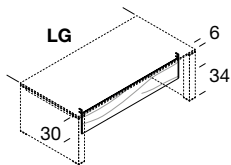

LG	W	D	H	Cod.	Price	Weight (Kg)	Volume (m ³)
160	118,5	1,8	30	GM.1603.00	95	6	0,01
180	138,5	1,8	30	GM.1803.00	102	6	0,01
200	158,5	1,8	30	GM.2003.00	108	7	0,01

Modesty panel
Modesty panel
Voile de fond
Knieraumblende
Faldón

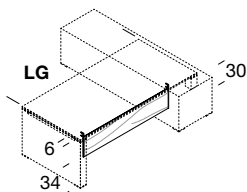

LG	W	D	H	Cod.	Price	Weight (Kg)	Volume (m ³)
160	98,5	1,8	30	GM.1403.00	91	5	0,01
180	118,5	1,8	30	GM.1603.00	95	6	0,01
200	138,5	1,8	30	GM.1803.00	102	6	0,01

Sottomano
Desk pad
Sous-main
Schreibunterlage
Vade

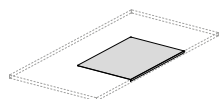

Finitura · Finish · Finition
Ausführung · Acabado

PL1

PE1

4 weeks

4 weeks

W	D	H	Cod.	Price	Price	Weight (Kg)	Volume (m ³)
70	50	2	CZ.0705.00	329	286	7	0,02

Jet

Cassettiere e mobili di servizio · Pedestals and service side units · Caissons et éléments de service
 Container und Technikcontainer · Cajoneras y módulos de servicio

Finitura · Finish · Finition
 Ausführung · Acabado

NC RN

W D H
 cm cm cm Cod.

Kg m³



++++
 weeks
3

Cassettiera su ruote con 4 cassetti, 1 serratura
 Pedestals on wheels, 4 drawers, 1 lock
 Caisson sur roulettes avec 4 tiroirs, 1 serrure
 Rollcontainer mit 4 Schubladen, 1 Schloss
 Cajonera sobre ruedas con 4 cajones, 1 cerradura



44,3 56,2 58,5 **ER.0406.F4** **548** 30 0,17

Cassettiera su ruote con 2 cassetti e 1 classificatore, 1 serratura
 Pedestals on wheels, 2 drawers, 1 filing unit, 1 lock
 Caisson sur roulettes avec 2 tiroirs et 1 classeur, 1 serrure
 Rollcontainer mit 2 Schubladen und 1 Hängeregistraturfach, 1 Schloss
 Cajonera sobre rueda con 2 cajones y 1 clasificador, 1 cerradura

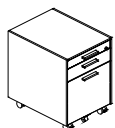

44,3 56,2 58,5 **ER.0406.F3** **563** 31 0,17

Su piedini con 2 ante, 4 cassetti, 3 serrature, 2 ripiani
 On feet with 2 doors, 4 drawers, 3 locks, 2 shelves
 Sur vérins avec 2 portes, 4 tiroirs, 3 serrures et 2 étagères
 Auf Füßen mit 2 Türen, 4 Schubladen, 3 Schlösser
 Sobre patas con 2 puertas, 4 cajones, 3 cerraduras, 2 estantes

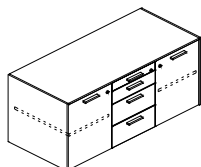

127,7 56,2 54 **ED.1305.F4** **1.047** 74 0,5

Su piedini con 2 ante, 2 cassetti, 1 classificatore, 3 serrature, 2 ripiani
 On feet with 2 doors, 2 drawers, 1 filing unit, 3 locks, 2 shelves
 Sur vérins avec 2 portes, 2 tiroirs, 1 classeur, 3 serrures et 2 étagères
 Auf Füßen mit 2 Türen, 2 Schubladen, 1 Hängeregistraturfach, 3 Schlösser
 Sobre patas con 2 puertas, 2 cajones y 1 clasificador, 3 cerraduras, 2 estantes

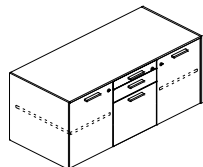

127,7 56,2 54 **ED.1305.F3** **1.040** 75 0,5

Set 5 ruote (2 con freno)
 5-wheel set (2 with brake)
 Kit de 5 roulettes (2 avec frein)
 Bausatz 5 Rollen (davon 2 mit Bremse)
 Conjunto de 5 ruedas (2 con freno)

Finitura · Finish · Finition
 Ausführung · Acabado

NE

++++
 weeks
2

Optional per ED.1305.F4
 Optional for ED.1305.F4
 Optionnel pour ED.1305.F4
 Optional für ED.1305.F4
 Opcional para ED.1305.F4

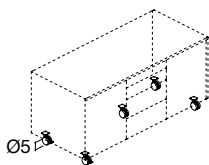

5 **5** **6,5** **CZ.0024.R5** **19** 1 0

Jet

Cassettiere e mobili di servizio · Pedestals and service side units · Caissons et éléments de service
 Container und Technikcontainer · Cajoneras y módulos de servicio

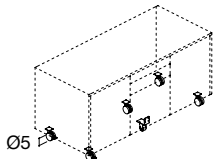
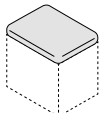
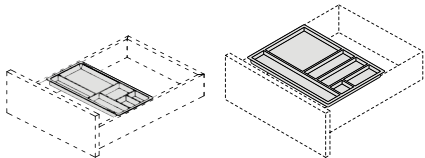
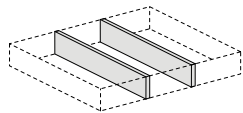
		W cm		D cm		H cm		Cod.		Finitura · Finish · Finition Ausführung · Acabado		Kg		m ³			
										NE							
										++++ weeks 2							
Set 5 ruote+1 per classificatore (2 con freno) 5-wheel set+1 for filing cabinet (2 with brake) Kit de 5 roulettes+1 pour le classeur (2 avec frein) Bausatz 5 Rollen+1 für Hängeregistratur (davon 2 mit Bremse) Conjunto de 5 ruedas+1 para clasificador (2 con freno)																	
										Optional per ED.1305.F3 Optional for ED.1305.F3 Optionnel pour ED.1305.F3 Optional für ED.1305.F3 Opcional para ED.1305.F3							
		5	5	6,5	CZ.0032.R5				41				1	0			
Cuscino sfoderabile con velcro Cushion with removable cover Coussin déhoussable avec velcro Abnehmbarer Kissenbezug mit Klettverschluss Cojín desenfundable con velcro																	
										Finitura · Finish · Finition Ausführung · Acabado		T1		T2			
										++++ weeks 4		++++ weeks 4					
		42	54	3	CU.0454.01				187		216		1	0,01			
Vaschetta portacancelleria Stationery tray Bac accessoires de bureau Utensilienschale Bandeja para papelería																	
										Finitura · Finish · Finition Ausführung · Acabado		NE					
												++++ weeks 3					
TZ.0012.00		34	16	2	TZ.0012.00				8				2	0			
TZ.0020.00		33,5	24	2	TZ.0020.00				14				0	0			
Separatore orizzontale per cassetto metallico (confezione da 2 pezzi) Horizontal separator for metal drawer (2-pieces package) Separateur horizontal pour tiroir métallique (set de 2 pièces) Waagerechter Metalltrennfächer (2 Stück-Packung) Separador horizontal para cajón metalico (paquete de 2 piezas)																	
										Finitura · Finish · Finition Ausführung · Acabado		NF					
												++++ weeks 3					
		32	0	8,8	TZ.0006.02				35				1	0			

Jet

Credenze · Credenza storage units · Dessertes Beistellmöbel · Credencia

BL MK Scocca
Frame · Structure
Korpus · Estructura

BP NE Maniglia, pomolo
Handle, knob · Poignée, pommeau
Griffe, Knauf · Manilla, pomo

BW NF Telaio anta
Frame · Châssis
Rahmen · Bastidor

Top, fianchi · Top, sides · Top, côtés
Abdeckplatte, Seitenteile · Top, costados

NC RN

Ante · Doors · Portes
Türen · Puertas

NC RN L_ C_ CK S_ CT

W D H
cm cm cm Cod.

Kg m³



Credenza con coppia ante, senza ripiani
Credenza unit with pair of doors, without shelves
Dessert avec une paire de portes, sans étagères
Beistellmöbel mit paar Türen, ohne Einlegeböden
Aparador con par de puertas, sin estantes

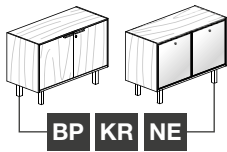

BP KR NE	102,4	46	73,7	DL.1007.A1	590	786	-	-	42	0,13
	102,4	46	73,7	DL.1007.V1	-	-	801	838	42	0,13

Credenza con 2 coppie ante, senza ripiani
Credenza unit with 2 pair of doors, without shelves
Dessert avec 2 paires de portes, sans étagères
Beistellmöbel mit 2 Paar Türen, ohne Einlegeböden
Aparador con 2 dos puertas, sin estantes

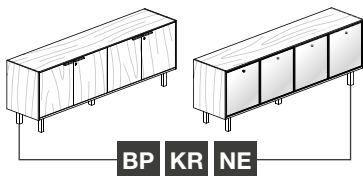

BP KR NE	202,4	46	73,7	DL.2007.A2	1.026	1.418	-	-	79	0,23
	202,4	46	73,7	DL.2007.V2	-	-	1.454	1.526	80	0,25

Credenza con 2 coppie ante, 1 ripiano fisso
Credenza unit with pair of doors, 1 fixed shelf
Dessert avec 2 paires de portes, 1 étagère fixe
Beistellmöbel mit 2 Paar Türen, 1 fester Boden
Aparador con par de puertas, 1 estante fijo

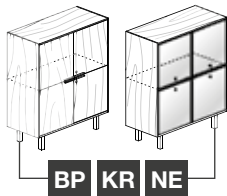

BP KR NE	102,4	46	124,9	DL.1012.A2	963	1.355	-	-	73	0,22
	102,4	46	124,9	DL.1012.V2	-	-	1.391	1.463	74	0,24

Credenza con 4 coppie ante, 2 ripiani fissi
Credenza unit with 2 pair of doors, 2 fixed shelves
Dessert avec 4 paires de portes, 2 étagères fixe
Beistellmöbel mit 4 Paar Türen, 2 feste Böden
Aparador con 2 dos puertas, 2 estantes fijos

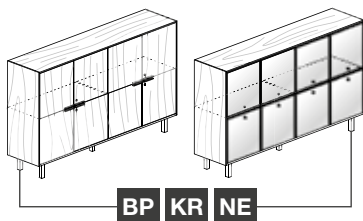

BP KR NE	202,4	46	124,9	DL.2012.A4	1.733	2.517	-	-	138	0,41
	202,4	46	124,9	DL.2012.V4	-	-	2.589	2.733	140	0,45

Ripiano
Shelf
Étagère
Einlegeboden
Estante

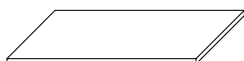

Finitura · Finish · Finition
Ausführung · Acabado

BL MK

++++
weeks
2

	96,3	41,4	2,5	RM.1004.01		36			7	0,02
--	------	------	-----	-------------------	--	-----------	--	--	---	------

Jet

Tavoli · Tables · Tables
Tische · Mesas

 1,8 cm

Gambe e piano · Legs and worktop · Piètements et plateau
Beine und tischplatte · Patas y plano

NC RN

W D H
cm cm cm Cod.

Kg m³



weeks

3 weeks

Tavolo
Table
Table
Tisch
Mesa

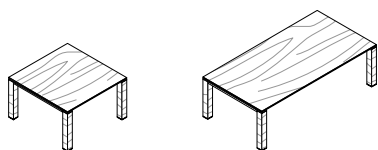

DM.1313.00
DM.1717.00

DM.2412.00

W	D	H	Cod.	Price	Weight (Kg)	Volume (m ³)
124	124	74	DM.1313.00	1.657	63	0,58
164	164	74	DM.1717.00	1.877	83	0,78
240	124	74	DM.2412.00	1.765	88	0,65

Tavolo con gamba centrale (8 posti)
Table with central leg (8-seater)
Table avec piètement central (8 places)
Tisch mit Fussgestell in der Mitte (8 personen)
Mesa con pata central (8 puestos)

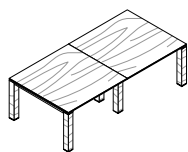

248	124	74	DM.2512.A2	2.786	112	0,86
-----	-----	----	------------	-------	-----	------

Tavolo con gamba centrale (12 posti)
Table with central leg (12-seater)
Table avec piètement central (12 places)
Tisch mit Fussgestell in der Mitte (12 personen)
Mesa con pata central (12 puestos)

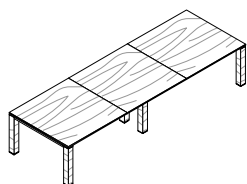

372	124	74	DM.3712.A3	3.189	145	0,95
-----	-----	----	------------	-------	-----	------

Tavolo con gamba centrale e spazzola passacavi
Table with central leg and brush element
Table avec piètement central et élément en brosse pour le passage des câbles
Tisch mit Fussgestell in der Mitte und Kabelauslassbürste
Mesa con pata central y cepillo pasacables

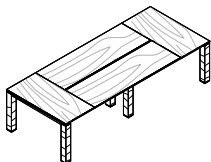

280	124	74	DM.2812.00	3.354	116	0,79
300	124	74	DM.3012.00	3.414	119	0,79
320	124	74	DM.3212.00	3.474	122	0,8
280	164	74	DM.2816.00	3.824	136	1,1
300	164	74	DM.3016.00	3.898	140	1,11
320	164	74	DM.3216.00	3.972	144	1,13

Tavolo con gamba centrale e spazzola passacavi
Table with central leg and brush element
Table avec piètement central et élément en brosse pour le passage des câbles
Tisch mit Fussgestell in der Mitte und Kabelauslassbürste
Mesa con pata central y cepillo pasacables

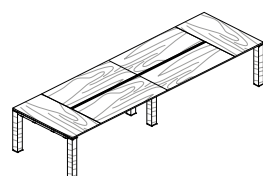

440	124	74	DM.4412.C0	4.108	154	0,84
480	124	74	DM.4812.C0	4.228	160	0,85
440	164	74	DM.4416.C0	4.672	182	1,23
480	164	74	DM.4816.C0	4.820	190	1,26

Jet

Tavoli · Tables · Tables
Tische · Mesas

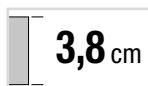

Gambe e piano · Legs and worktop · Piètements et plateau
Beine und tischplatte · Patas y plano

NC RN

W D H
cm cm cm Cod.

Kg m³



3 weeks

Tavolino basso
Low table
Petite table basse
Niedriger Tisch
Mesita baja



W	D	H	Cod.	Price	Weight	Volume
60	60	40	DM.0606.40	239	22	0,05
120	60	40	DM.1206.40	373	33	0,08

Tavolo con colonna
Table with column leg
Table avec piètement colonne
Tisch mit Säule
Mesa con pata de columna

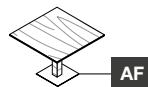

W	D	H	Cod.	Price	Weight	Volume
100	100	76	DM.1010.A4	753	61	0,14
124	124	76	DM.1313.A4	900	75	0,18

Tavolo
Table
Table
Tisch
Mesa

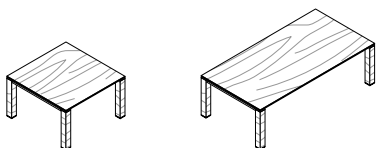

DM.1313.04
DM.1717.04

DM.2412.04

W	D	H	Cod.	Price	Weight	Volume
124	124	76	DM.1313.04	1.813	84	0,61
164	164	76	DM.1717.04	2.293	119	0,83
240	124	76	DM.2412.04	2.250	129	0,71

Tavolo con gamba centrale (8 posti)
Table with central leg (8-seater)
Table avec piètement central (8 places)
Tisch mit Fussgestell in der Mitte (8 personen)
Mesa con pata central (8 puestos)

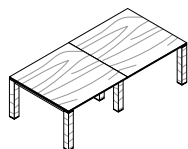

W	D	H	Cod.	Price	Weight	Volume
248	124	76	DM.2512.D2	3.098	154	0,92

Tavolo con gamba centrale (12 posti)
Table with central leg (12-seater)
Table avec piètement central (12 places)
Tisch mit Fussgestell in der Mitte (12 personen)
Mesa con pata central (12 puestos)

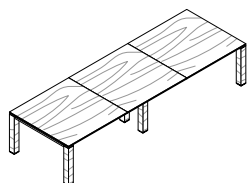

W	D	H	Cod.	Price	Weight	Volume
372	124	76	DM.3712.D3	3.657	209	1,05

Jet

Tavoli · Tables · Tables
Tische · Mesas

3,8 cm

Gambe e piano · Legs and worktop · Piètements et plateau
Beine und tischplatte · Patas y plano

NC RN

W D H
cm cm cm Cod.

Kg m³



3 weeks

Tavolo con gamba centrale e spazzola passacavi
Table with central leg and brush element
Table avec piètement central et élément en brosse pour le passage des câbles
Tisch mit Fussgestell in der Mitte und Kabelauslassbürste
Mesa con pata central y cepillo pasacables

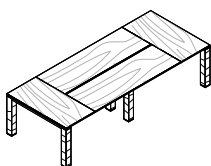

W	D	H	Cod.	Price	Weight (Kg)	Volume (m ³)
280	124	76	DM.2812.04	4.398	163	0,95
300	124	76	DM.3012.04	4.534	169	0,99
320	124	76	DM.3212.04	4.656	176	0,98
280	164	76	DM.2816.04	5.128	199	1,25
300	164	76	DM.3016.04	5.254	207	1,27
320	164	76	DM.3216.04	5.380	215	1,29

Tavolo con gamba centrale e spazzola passacavi
Table with central leg and brush element
Table avec piètement central et élément en brosse pour le passage des câbles
Tisch mit Fussgestell in der Mitte und Kabelauslassbürste
Mesa con pata central y cepillo pasacables

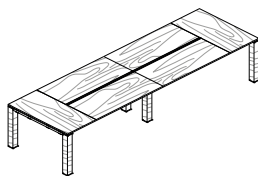

W	D	H	Cod.	Price	Weight (Kg)	Volume (m ³)
440	124	76	DM.4412.C4	5.750	227	1,1
480	124	76	DM.4812.C4	6.022	240	1,19
440	164	76	DM.4416.C4	6.726	279	1,44
480	164	76	DM.4816.C4	6.978	296	1,48

Coppia pannelli di tamponamento per gambe intermedie (montati)
Pair of panels for cabled legs assembled
Paire de panneaux de remplissage pour piètements intermédiaires (Assemblé)
Paar Abdeckungspaneel für Zwischenfussgestell (gebaut)
Par de paneles de taponado para patas intermedias (ensamblado)

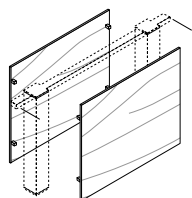

D	W	D	H	Cod.	Price	Weight (Kg)	Volume (m ³)
D.124	47,2	1,8	63,8	DB.0464.PA	179	7	0,02
D.164	80	1,8	63,8	DB.0864.PA	276	13	0,04

Jet

Tavoli · Tables · Tables
Tische · Mesas

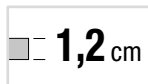

Gambe · Legs · Piètements Beine · Patas	
NC	RN
Piano · Worktop · Plateau Tischplatte · Plano	
C_	S_

W cm D cm H cm Cod.



Tavolo con colonna
Table with column leg
Table avec piètement colonne
Tisch mit Säule
Mesa con pata de columna

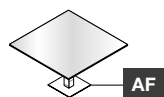

100	100	74	DM.1010.A0	1.591	1.739	73	0,17
124	124	74	DM.1313.A0	1.847	2.049	94	0,22

Tavolo
Table
Table
Tisch
Mesa

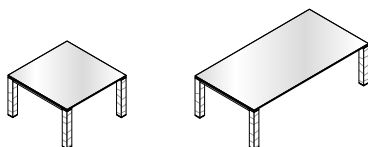

DM.1313.00

DM.2412.00

124	124	74	DM.1313.00	2.621	2.852	103	0,65
240	124	74	DM.2412.00	3.383	3.756	165	0,78

Tavolo con gamba centrale (8 posti)
Table with central leg (8-seater)
Table avec piètement central (8 places)
Tisch mit Fussgestell in der Mitte (8 personen)
Mesa con pata central (8 puestos)

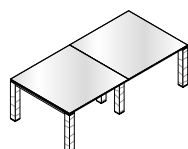

248	124	74	DM.2512.A2	4.714	5.176	192	1,01
-----	-----	----	------------	-------	-------	-----	------

Tavolo con 2 gambe centrali (12 posti)
Table with 2 central legs (12-seater)
Table avec 2 piètements central (12 places)
Tisch mit 2 Fussgestell in der Mitte (12 personen)
Mesa con 2 patas central (12 puestos)

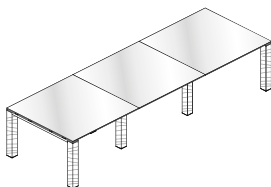

372	124	74	DM.3712.A3	6.763	7.456	281	1,36
-----	-----	----	------------	-------	-------	-----	------

Technical descriptions

MELAMINE TOPS: made from 18-mm thick chipboard panels and covered with a decorative paper impregnated with melamine resins (density 650Kg/m³ E1, CARB PH 2/TSCA Title VI. Panels with low formaldehyde emission, less than 50% of class E, according to UNI EN standards. Fire reaction class Ds2, d0 – Dfl-S1) and with a 2 mm-thick rounded solid ABS edge (38mm tops=1mm thick abs edge). The tops are hooked onto the reinforced nylon clips positioned along the beams of the structure using self-threading screws which are connected to the steel inserts under the top. In the “meeting table” versions, tops have a “brush” profile applied to the internal side in order to allow for cable outlets directly onto the top. Optional accessories can be inserted into the previously perforated wooden tops to allow for the passage of cables such as a simple ABS cover with a diameter of 80 mm or a plug box with a cover and cable gland fixture.

GLASS TOPS: made from 12 mm-thick toughened glass with a shiny rounded edge; the surface below is sanded or can be lacquered in various colours. The glass tops are fixed to the structure using suction cups.

DOUBLE-SPAN STRUCTURE: made from 2 mm-thick drawn steel tubes aluminium-coloured, 70 x 30 mm, to which 2 square shaped legs, 100 x 100 mm, are connected, and made from melamine wood obtained with folding technology in colours matching the tops. The intermediate support legs at the centre of the meeting tables are positioned further back to allow use of the entire top surface. All the legs have 10 mm height regulating feet.

PANELLED STRUCTURE: further to the square support leg version, it is also available a panel leg which is 100 mm thick. The leg is made from the same technology used for the square legs that are fixed to the steel beam to create a single, solid support element. All the legs have 10 mm height regulating feet.

BEAMS: the support legs are connected using a pair of telescopic beams which are made from 40 x 40 mm square drawn steel tubes. At the ends of the beams there are coupling elements for the support legs in aluminium-coloured ABS with a chrome-colour finishing on the external part; extension of the telescopic beams varies from 800 to 1000mm-from 1200 to 1800mm-from 2000 to 2400 mm. The beams also allow for the application, through the use of reinforced nylon elements, of tilting or modular baskets, made from epoxy powder coated steel wire with a 6 mm perimeter section and an internal mesh of 3.5 mm, required to transfer and hold electrical, telephone and computer cables. Beams of the extension tops with frame or of the lateral “bridge” solutions can also be fixed to the beams of the workstation using a suitable hooking system which is made from ABS moulded elements. The beams are finished with black epoxy paint

MELAMINE MODESTY PANELS: they are made from 18-mm thick melamine panels (density 650Kg/m³ E1, CARB PH 2/TSCA Title VI. Panels with low formaldehyde emission, less than 50% of class E, according to UNI EN standards. Fire reaction class Ds2, d0 – Dfl-S1) edged on 4 sides with melamine paper, with a 1 mm-thick solid ABS along the horizontal edging and a 2 mm radius. They are fitted to the telescopic beams of the structure by a pair of fixing brackets which are mounted along the vertical edges of the modesty panel itself.

PEDESTALS AND SERVICE MODULES: structure made of 18 mm thick chipboard (density 650Kg/m³ E1, CARB PH 2/TSCA Title VI. Panels with low formaldehyde emission, less than 50% of class E, according to UNI EN standards. Fire reaction class Ds2, d0 – Dfl-S1). The fronts are 18 mm thick, the backs are structural and made of 12 mm thick chipboard (weight 620 Kg per m³, class E1 with low formaldehyde emission, class 2 fire reaction according to ISO standards), top and side panels are 12 mm thick. The doors are fitted with anticorrosion treated hinges with an opening of 105° and soft slow closure, the locks are a cylindrical Yale type with articulated key grip. Top, fronts, doors, backs and side panels are edged along the perimeter with 1 mm ABS and 2 mm radius. The handles are ABS colour aluminium. The drawers are applied with guides or with simple sliding extraction on self-lubricating wheels with soft closure or telescopic extraction metal guides with integrated soft closure for filing cabinets, equipped with anticorrosion treated ball carriage, made of folded sheet metal with an 8/10 thickness and painted with epoxy powders. A stationary drawer is always supplied, equipped with simple sliding extraction guides on small self-lubricating wheels. Appropriate drilling along the side edges allows the installation of optional accessories, such as horizontal separators file holder separators. 33 and 39 cm files can be hung from the file hanger frame. The drawers are equipped with 5 cm diameter swivel wheels, 2 of which with a brake; the filing cabinets have the 5th wheel with a function to prevent overturning; the service modules are equipped with Ø52 x h.18 mm feet with adjustable foot inside the furniture. The furniture can also be positioned on 5 cm diameter swivel wheels, 2 of which with a brake. The filing cabinets have the 5th wheel with a function to prevent overturning. Some compositions are equipped with a technical module with CPU port and cable passage designed to hang under the desk to make maximum use of less accessible areas.

STORAGE UNITS: body made of 18 mm thick chipboard (density 650Kg/m³ E1, CARB PH 2/TSCA Title VI. Panels with low formaldehyde emission, less than 50% of class E, according to UNI EN standards. Fire reaction class Ds2, d0 – Dfl-S1) edged with melamine paper on 4 sides. Top and side panels are in 12 mm thick and the edge along the perimeter sides is 1 mm thick – 2 mm radius rounded ABS. Doors made of 18 mm melamine, fitted with anticorrosion treated hinges with an opening of 105°, the locks are a cylindrical Yale type with articulated key grip. The handles are made of ABS with aluminium finish. Glass doors made of 4 mm tempered etched or coloured glass, equipped with extruded aluminium perimetrical frame or painted white or black; lock and hinges at 170° cannot be mounted on these doors. The furniture is positioned on an 18 mm thick melamine base, supported by feet made of chrome-coloured 40x40xh.195mm square ABS.

legno · veneer · bois · holz · madera

R_



rovere laccato nero
black lacquered oak
chêne laqué noir
schwarz lackierter Eiche
roble lacado negro

RK



rovere Carbon
Carbon oak
chêne Carbon
Eiche Carbon
roble Carbon

RC



rovere tabacco
tobacco oak
chêne tabac
Eiche Tabak
roble tabacco

RT



rovere grigio scuro
dark grey oak
chêne gris foncé
dunkelgraue Eiche
roble gris oscuro

RU



rovere grigio
grey oak
chêne gris
Eiche grau
roble gris

RG



rovere naturale
natural oak
chêne naturel
Natur Eiche
roble natural

RR



rovere laccato bianco
white lacquered oak
chêne laqué blanc
weiß lackierter Eiche
roble lacado blanco

RB



rovere laccato titanio
titanium lacquered
oak chêne laqué titane
titan lackierter Eiche
roble lacado titanio

R4



rovere laccato tortora
turtledove lacquered oak
chêne laqué tourterelle
turteltaube lackierter
Eiche roble lacado tortora

R2

melaminico · melamine · mélamine · melamin · melamina

M



nero
black
noir
schwarz
negro

MK



grigio titanio
titanium grey
gris titane
titangrau
gris titanio

GS



grigio perla
pearl-grey
gris perle
perlgrau
gris perla

GP



tortora
turtledove
tourterelle
taubengrau
törtola

MO

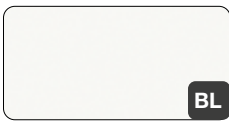

bianco
white
blanc
weiß
blanco

BL



noce Lux
walnut Lux
noyer Lux
lux Nussbaum
nogal Lux

NX



noce canaletto
canaletto walnut
noyer canaletto
Canaletto Nussbaum
nogal canaletto

NC



rovere naturale
natural oak
chêne naturel
Natur Eiche
roble natural

RN



rovere anticato
traditional oak
chêne vieilli
Eiche Antik
roble antiguo

RA



rosso rubino
ruby red
rouge rubis
rubinrot
rojo rub

RD



RD = Solo Domomag
Only Domomag · Seulement Domomag
Nur Domomag · Sólo Domomag



RA
Superficie antibatterica
Antibacterial surface
Surface antibactérienne
Antibakterielle Oberfläche
Superficie antibacteriana

bordo ABS · ABS edge · chant ABS · ABS-Kante · borde ABS

A



nero
black
noir
schwarz
negro

MK



grigio titanio
titanium grey
gris titane
titangrau
gris titanio

GS



grigio perla
pearl-grey
gris perle
perlgrau
gris perla

GP



tortora
turtledove
tourterelle
taubengrau
törtola

MO

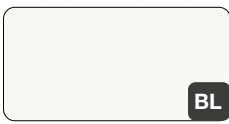

bianco
white
blanc
weiß
blanco

BL



noce Lux
walnut Lux
noyer Lux
lux Nussbaum
nogal Lux

NX



noce canaletto
canaletto walnut
noyer canaletto
Canaletto Nussbaum
nogal canaletto

NC



rovere naturale
natural oak
chêne naturel
Natur Eiche
roble natural

RN



rovere anticato
traditional oak
chêne vieilli
Eiche Antik
roble antiguo

RA



oliva
olive
olive
olive
oliva

L8



terracotta
terracotta
terre cuite
terracotta
terracota

L10

strutture metalliche · metal structures · structures métalliques · metallgestelle · estructuras metálicas

 NF nero black noir schwarz negro	 FG ferro grezzo raw steel métal brut rohes Metall hierro bruto	 GF grigio titanio titanium grey gris titane titangrau gris titanio
 TF tortora turtledove tourterelle taubengrau törtola	 AF epox alluminio silver epoxy epoxy aluminium epoxy aluminium epoxidico aluminio	 BW bianco white blanc weiß blanco
 VF oliva olive olive olive oliva	 CF terracotta terracotta terre cuite terracotta terracota	 KR cromo lucido glossy chrome chromé brillant Chrom poliert cromo brillo
 BR brunito (solo Arche) burnished (only Arche) bruni (seulement Arche) brüniert (nur Arche) bruñido (sólo Arche)	 EF grigio ombra shadow grey gris ombre vulcanschwarz sombra gris	 PF rame rosa pink copper cuivre rose kupfer-Pink cobre rosa

⚠ seating NF = alluminio verniciato nero, black painted aluminium aluminium, peint noir aluminium, schwarz lackiert, aluminio pintado negro
hub KR = acciaio cromato (All), chromed steel (All), acier chromé (All), verchromter Stahl (All), acero cromado (All)

FG: La finitura ferro grezzo "FG" risalta la natura "industriale" del metallo grazie ad un trattamento protettivo trasparente. Differenze di tonalità, abrasioni, striature e saldature sono tipici della materia prima stessa e delle successive lavorazioni e sono tra gli elementi caratterizzanti del prodotto e per questo non contestabili.
FG: The raw steel finish "FG" emphasizes the "industrial" nature of the metal thanks to a transparent protective treatment. Differences in shades, abrasions, stripes and welds are typical of the raw material and subsequent processes, and are among the characteristic elements of the product, therefore not claimable.
FG: La finition en métal brut "FG" démarque la nature "industrielle" du Métal grâce à un traitement avec une protection transparent. Les différences dans les nuances, les abrasions et les soudures sont typiques de la matière première et des ultérieures process de production et font partie des éléments caractéristiques du produit et donc non contestables.
FG: Das rohes Metall-Finish "FG" sticht besonders hervor der "Industriellen" Natur der Metall durch einer Transparenten Schutz Behandlung. Unterschiede in Farbton, Abrieb, Streifen und Schweissungen sind typisch für den Rohstoff und die nachfolgenden Prozesse und gehören zu den charakteristischen Elementen des Produkts und daher sind nicht anfechtbar.
FG: El acabado de hierro bruto "FG" destaca la naturaleza "industrial" del Metal gracias a un tratamiento protector transparente. Las diferencias en los tonos, abrasiones, rayas y soldaduras son típicas de la materia prima y los procesos posteriores y se encuentran entre los elementos característicos del producto y, por lo tanto, es indiscutible.

laccato opaco · lacquered matt · lacqué mat · matt lackiert · lacado mate

L	 LN	 L4	 L2	 LB
	 L7	 L5	 L8	 L9
	 L10	 L11	 L12	 LJ

pelle · leather · cuir · Leder · piel

PL1	 Z01	 Z02	 Z03	 Z05	 Z13
	 Z06	 Z14	 Z10	 Z11	 Z12

pelle ecologica · eco-leather · peau écologique · Kunstleder · eco-piel

PE1	 E01	 E02	 E10	 E03	 E04
	 E11	 E05	 E12	 E07	 E08
	 E09				

acrilico lucido · glossy acrylic · acrylique brillant · glänzende acryl · acrílico brillo



nero
black
noir
schwarz
negro



bianco
white
blanc
weiß
blanco

vetro stampato · printed glass · verre imprimé · Bedrucktes Glas · vidrio impreso

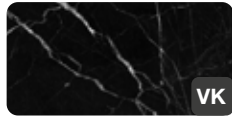

nero marquinia
black marquinia
noir marquinia
schwarz marquinia
marquinia negro



bianco calacatta
white calacatta
blanc calacatta
weiß calacatta
calacatta blanco

vetro temperato retrolaccato · back-lacquered tempered glass · verre retro-lacqué trempé · sicherheitsglas rückseitig lackier · vidrio retrolacado templado **C_** (lucido · glossy · brillant · poliert · brillo) **S_** (opaco · matt · opaque · matt · mate)



nero
black
noir
schwarz
negro



titanio
titanium
titane
titan
titanio



tortora
turtledove
tourterelle
taubengrau
tortola



bianco
white
blanc
weiß
blanco

vetro temperato · tempered glass · verre trempé · sicherheitsglas · vidrio templado



fumé
transparent smoke grey
gris fumé
Rauchglas
gris ahumado



satinato
frosted
satiné
geätzttem Glas
satinado



trasparente
transparent
transparent
Klarsicht Glas
transparente

plastica · plastic · plastique · Plastik · plástico



nero
black
noir
schwarz
negro

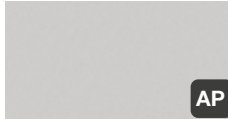

alluminio
aluminium
aluminium
aluminium
aluminio



bianco
white
blanc
weiß
blanco



cromo lucido
glossy chrome
chromé brillant
Chrom poliert
cromo brillo



trasparente
transparent
transparent
klarsicht
transparente

tecnopolimero · technopolymer · technopolymère · technopolymer · tecnopolimero



nero
black
noir
schwarz
negro

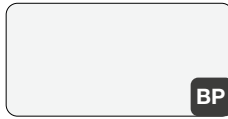

bianco
white
blanc
weiß
blanco



alluminio spazzolato lucido
polished brushed aluminum
aluminium brossé poli
aluminium poliert
aluminio brillo pulido



P1P



P2P



P6P



P4P



P5P

metacrilato · methacrylate · méthacrylate · Methacrylat · metacrilato



nero opaco
black matt
noir mat
schwarz matt
negro mate



grigio opaco
grey matt
gris mat
grau matt
gris mate



bianco opaco
white matt
blanc mat
weiß matt
blanco mate